

2024

# MAGAZINE

concept 130

REVISTA | MAGAZINE | MAGASIN

# THE KITCHEN CONCEPT

## RELIABLE & UNIQUE

The broad range of colours, fittings and designs enables individual kitchen architectures to meet sophisticated requirements. With concept130, even unusual kitchen ideas can be implemented creatively and almost without limits. Concept130 reinterprets the modern kitchen and merges it with living areas to create a single living space. Individual requirements for special kitchen and living preferences can thus be realised as a tailored solution.

### EL CONCEPTO DE COCINA

#### SEGURO EN LA PLANIFICACIÓN & ÚNICO

Con concept130 incluso las ideas de cocina más originales se pueden hacer realidad de forma creativa y casi sin límites. concept130 reinterpreta la cocina moderna y fusiona las zonas de la cocina y del salón a un espacio único para vivir. Así los requisitos individuales para los deseos de las cocinas y de los espacios de la vivienda se pueden realizar a medida.

### IL CONCETTO DI CUCINA

#### AFFIDABILE E UNICA

La grande varietà di colori, finiture e design permette di progettare cucine personalizzate che soddisfino le esigenze più sofisticate. Con la linea concept130 anche le idee più insolite si lasciano realizzare con creatività e praticamente senza limitazioni. concept130 reinterpreta la cucina in chiave moderna facendone insieme alla zona living un unico spazio tutto da vivere. I desideri e i sogni più personali in cucina e soggiorno possono diventare realtà con un progetto su misura.

### KØKKENKONCEPTET

#### PLANLÆGNINGSSIKKER & ENESTÅENDE

Det store udvalg af farver, beslag og design muliggør skabelsen af individuelle køkkenarkitekturer til sofistikerede krav. Med concept130 kan selv usædvanlige køkkenidéer realiseres kreativt og næsten uden grænser. concept130 nyfortolker det moderne køkken og forener køkken og opholdsrum i ét. Individuelle krav til særlige køkken- og boligønsker kan derfor udføres på en skræddersyet måde.





## IMPRESSIVE METALLIC AND VELVETY

Metallic look, sensual feel. The fronts in metallic stone grey and metallic sand grey perfectly match each other and create a beautiful contrast to the light wooden floor. The polymer glass surfaces feel pleasantly velvety and soft, being particularly easy to clean and yet robust in daily use. Kitchen living space reinterpreted.

### ASPECTO METÁLICO, TACTO SENSUAL.

*Los frentes en piedra gris metalizados y en gris arena metalizados corresponden perfectamente entre sí y forman un bello contraste con el suelo de madera claro. Las superficies de cristal polímero tienen un tacto aterciopeladas, son especialmente fáciles de limpiar y, sin embargo, son robustos para el uso diario. La cocina como espacio para vivir interpretado de una nueva forma.*

### NOTEVOLE METALLICA E VELLUTATA

*Metallica di aspetto, sensuale al tatto. Le ante color grigio pietra e grigio sabbia metallizzato sono in perfetta armonia tra di loro e creano uno splendido contrasto con il legno chiaro del pavimento. Le superfici in vetro polimerico sono piacevolmente vellutate al tatto, facilissime da pulire e tuttavia robuste per l'uso quotidiano. Una reinterpretazione della cucina come ambiente da vivere.*

### IMPONERENDE METALLISK OG FLØJLSBLØD

*Metallisk look, sensuel følelse. Fronterne i metallisk stengrå og metallisk sandgrå passer perfekt til hinanden og danner en smuk kontrast til det lyse trægulv. Polymerglasoverfladerne føles behageligt fløjlsløde, er særligt nemme at rengøre og alligevel robuste i daglig brug. Nyfortolkning af køkkenets opholdsrum*



**SMART-GL** Metallic sand grey effect | Gris arena metálico repro. | Effetto grigio sabbia metallizzato | Sandgrå metallic effekt

**SMART-GL** Metallic stone grey effect | Gris piedra metálico repro. | Effetto grigio pietra metallizzato | Stengrå metallic effekt



**122**  
PerfectSense®  
**WORKTOP**  
Encimera  
Piano di lavoro  
Bordplade



DEEP FEELINGS FOR EARTHY COLOURS. THE CLEAR FRONTS PERFECTLY HARMONISE WITH BLACK CHANNEL HANDLE AND THE THIN, BLACK PERFECTSENSE® WORKTOP. TO AVOID TOO SOMBRE A TONE, THE CEILING AND WALLS ARE KEPT IN A LIGHT TONE. ELEGANT WOOD FITTINGS IN SAND AND BEIGE COLOURS SKILFULLY ROUND OFF THE KITCHEN'S AMBIENCE.

*Pasión por los colores terrosos. Los frentes luminosos encajan perfectamente con las golas negras y la fina encimera PerfectSense® en negro. El tono claro que conservan el techo y las paredes impiden que el color oscuro resulte excesivo. Las bellas decoraciones de madera en tonos arena y beige dan el toque final al ambiente de esta cocina.*

*Sensazioni profonde con i colori terrigni. Le ante chiare si combinano a meraviglia con il nero dei profili gola e lo snello top nero PerfectSense®. Per controbilanciare gli accenti scuri, il soffitto e le pareti hanno tonalità chiare. Bellissime decorazioni in legno, sabbia e beige danno un tocco di classe all'intero ambiente della cucina.*

*Kærlighed til jordfarver. De klare fronter passer perfekt til de sorte lister og den tynde PerfectSense®-bordplade i sort. For at de mørke farver ikke skal tage overhånd, er loft og vægge holdt i en lys tone. Smukke dekorationer i træ, sand og beige giver køkkenets atmosfære et elegant touch.*



## FABULOUS CHARMING AND YOUTHFUL

The daily boost of freshness. The limestone-coloured niche panelling with the generous shelves and the light worktop stand in pleasant contrast to the olive-green fronts. The equipment and functional furnishings provide enormous storage space and favour a tidy environment. Our motto: Colourful boldness!

### FORMIDABLE ENCANTADORA Y JUVENIL

*La explosión de frescor diaria. El revestimiento del entrepaño de color calizo con las amplias estanterías y la encimera clara crean un contraste muy agradable con los frentes en verde oliva. El equipamiento y el diseño funcional ofrecen un enorme espacio de almacenamiento con el que mantener el orden es muy sencillo. Como dice nuestro lema, vale la pena atreverse más con el color.*

### DA FAVOLA GIOVANE E AFFASCINANTE

*Il tocco di freschezza giornaliero. Il rivestimento color calcare delle nicchie dotate di grandi ripiani e il piano di lavoro chiaro creano un delizioso contrasto con i frontali verde oliva. L'allestimento e l'attrezzatura funzionale offrono moltissimo spazio per riporre e facilitano ordine e pulizia. Il nostro motto: più coraggio nel colore!*

### FABELAGTIG CHARMERENDE

*Et dagligt kick af friskhed. De kalkstensfarvede nichepaneler med de store hylde og den lyse bordplade er en flot kontrast til de olivengrønne fronter. Udstyret og de funktionelle møbler giver masser af opbevaringsplads og gør det nemt at holde orden. Vores motto: Farver med mod!*



SCALA Olive green | Verde olivo | Verde oliva | Olivengrøn

## DIVE INTO GREEN

Green is now in vogue in all shades and nuances. Our olive green is a shade that comes across absolutely naturally. It can be perfectly matched with light as well as dark shades and is extremely homely. We focus on new designs, innovative techniques and special materials while bearing all sustainability aspects in mind.



115

### WORKTOP

Encimera  
Piano di lavoro  
Bordplade

## CON VISTAS AL VERDE

*El verde está de moda en todos los matices y tonalidades. Nuestro verde oliva es un tono que se ve absolutamente natural. Combina a la perfección tanto con colores claros como oscuros y resulta verdaderamente acogedor. Apostamos por diseños nuevos, tecnologías innovadoras y materiales especiales, pero siempre sin olvidar los aspectos relacionados con la sostenibilidad.*

## UNO SGUARDO NEL VERDE

*Il verde oggi è molto di moda in tutte le sue sfumature e tonalità. Il nostro verde oliva è una tonalità di origine assolutamente naturale. Si abbina perfettamente con colori chiari e scuri ed è particolarmente accogliente. Adottiamo nuovi design, tecniche innovative e materiali particolari, tenendo però sempre d'occhio gli aspetti della sostenibilità.*

## UDSIGT TIL DET GRØNNE

*Lige nu er grøn på mode i alle nuancer og afskygninger. Vores olivengrøn er en nuance, der falder helt naturligt ind med omgivelserne. Den kan kombineres perfekt med både lyse og mørke nuancer og er ekstremt boligegnet. Vi fokuserer på nye design, innovative teknikker og specielle materialer, men har altid bæredygtighedsaspektet for øje.*





## SOOTHING LIVELY & POWERFUL

Experience simple elegance at the highest level. In this kitchen, clearly defined areas in rich colours meet modern technology and fuse confidently together. The result: A comfortable room in which living and working in one area are perfectly compatible and the kitchen quickly becomes the focus of the house.

### RECONFORTANTE REBOSANTE DE VIDA Y DE FUERZA

*Disfrute de una elegancia de primera clase sin adornos. En esta cocina, las zonas bien diferenciadas en colores intensos confluyen con la tecnología moderna y se fusionan con seguridad. El resultado: una estancia cómoda que permite vivir y trabajar en un mismo sitio y donde la cocina no tarda en convertirse en el centro de la casa.*

### PIACEVOLMENTE VIVACE ED ENERGICA

*Essenziale, senza fronzoli, ma sempre elegante ai massimi livelli. In questa cucina le varie zone operative, evidenziate da colori intensi, si incontrano, sicure di sé, e si fondono tra di loro. Ne risulta uno spazio confortevole, dove il soggiornare ed il lavorare vanno d'accordo e si mettono sullo stesso piano, e la cucina diventa subito il centro della casa.*

### VELGØRENDE LEVENDE & KRAFTFULDT

*Oplev enkel elegance på højeste niveau. I dette køkken smelter klart definerede områder i mættede farver med den største selvfølghed sammen med moderne teknik. Resultatet: Et behageligt rum, hvor dagligliv og arbejde i samme rum går op i en højere enhed, og hvor køkkenet hurtigt bliver husets centrale midtpunkt.*

**BALI** Walnut effect | Nogal repro. | Effetto Noce | Valnød effekt

**LASER SOFT** Black | Negro | Nero | Sort





## PERFECT EXECUTION

The integrated home office space is great for working. It offers enough storage space for filing as well as for laptop & co. All processes in the kitchen can be controlled quickly. The harmonious architecture creates an ambience that looks as if it were made from one piece.

### IMPLEMENTACIÓN PERFECTA

*El puesto integrado permite teletrabajar de maravilla. Con suficiente espacio de almacenaje, pero apto también para el portátil y demás accesorios. Muy cerca, para no perderse nada de lo que se cuece en la cocina. La arquitectura armoniosa crea un ambiente uniforme.*

### UNA REALIZZAZIONE PERFETTA

*In questa postazione per lo smart working si lavora che è una meraviglia. C'è spazio a sufficienza per la documentazione, per il computer e tutto il resto. Tutti i processi in cucina possono essere controllati nella via più breve. Un'architettura armoniosa che crea un ambiente perfettamente integrato.*

### PERFEKT I PRAKSIS

*Den integrerede home-office arbejdsplads byder på fremragende arbejdsforhold. Den har god plads til opbevaring af laptop & co, og alle andre gøremål i køkkenet er lige ved hånden. Den harmoniske arkitektur sørger for et gennemgående miljø.*







THIS IS WHERE YOU COME ALIVE AGAIN.  
THE POWERFUL, PROUD COLOUR COMBINATION  
FITS PERFECTLY INTO MODERN LIVING SPACES  
AND, IN CONJUNCTION WITH INNOVATIVE  
TECHNOLOGY, ENSURES EVEN MORE WELL-  
BEING WITHIN YOUR OWN FOUR WALLS.

*El lugar para cargar pilas. Esta combinación de  
colores fuertes e imponentes encaja perfecta-  
mente con los entornos domésticos modernos  
y, junto con una tecnología innovadora, hará que  
aún se sienta más a gusto en casa.*

*Uno spazio per rifare il pieno di energie. La fiera  
e vigorosa combinazione di colori si adatta per-  
fettamente alle ambientazioni moderne e grazie  
alle tecnologie innovative aumenta ancora di più  
il benessere tra le quattro mura domestiche.*

*Her kan livet udfolde sig. Den stærke og selv-  
bevidste farvekombination passer fremragende  
til moderne boligmiljøer og skaber i forbindelse  
med innovativ teknik et endnu mere behageligt  
liv indenfor hjemmets fire vægge.*



635

**HANDLE**

Tirador  
Maniglia  
Greb



122

PerfectSense®

**WORKTOP**

Encimera  
Piano di lavoro  
Bordplade

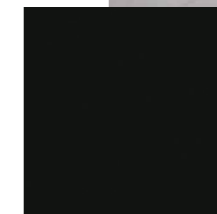



## FLAWLESS YOUNG AND FRESH

For all those who love clear lines, soft shapes and lots of white. Sick of white? Not a chance! Whether romantic or minimalist, it all depends on the ingredients. This white kitchen conveys the beauty of everyday life with its shapely, simple and flawless presence. A picture-perfect kitchen that effortlessly wins you over.

### INMACULADA JUVENIL Y FRESCA

*Para todo el mundo que sienta pasión por las líneas claras, las formas suaves y mucho, mucho blanco. ¿Le cansa el blanco? ¡Imposible! Ya sea en estilo romántico o minimalista, el secreto está en los ingredientes. Esta cocina blanca transmite la belleza de lo cotidiano y, a la vez, muestra un aspecto elegante, sencillo e imaculado. Una cocina preciosa que sabe cómo seducir.*

### IMMACOLATA GIOVANE E FRESCA

*Per chi ama le linee pulite, le forme delicate e tanto, tanto bianco. Stancarsi del bianco? Impossibile! Romantica o minimalista, la scena qui è tutta per gli ingredienti. Questa cucina bianca porta la bellezza nella quotidianità, presentandosi estetica, semplice e immacolata. Una cucina iconica che sa convincere.*

### UFEJLBARLIG UNG OG FRISK

*Til alle dem, der elsker klare linjer, bløde former og masser af hvidt. Træt af hvidt? Umuligt! Om det er romantisk eller minimalistisk, det afhænger af tilbehøret. Dette hvide køkken bringer skønheden i hverdagen tæt på og fremstår formfuldendt, enkelt og fejlfrit. Et smukt køkken, der ved, hvordan man overbeviser.*

 **TOP SOFT** White | Blanco | Bianco | Hvid  
TOUCHfree





## CONSISTENTLY WHITE

It's less complicated than you think! When white plays the leading role, the rest of the cast falls in line. Harmoniously combined with light, soft colours or wood tones, white will surely turn all heads.



THIS IS HOW KITCHEN AND LIVING COME CLOSER TOGETHER. THE PRACTICAL COAT RACK OFFERS SPACE FOR JACKETS AND COATS - AND FITS PERFECTLY IN SMALL ROOMS OR HALLWAYS. ALSO IDEAL TO MAKE THE BEST USE OF CRAMPED SPACES IN NOOKS AND CRANNIES.

*La unión de la cocina y el hogar. Además del espacio para las chaquetas y los abrigos, este práctico guardarropa queda perfecto en habitaciones pequeñas o pasillos. También es una opción excelente para llenar huecos, ya que permite aprovechar al máximo el espacio disponible.*

*Cucina e soggiorno non sono mai stati più vicini. Il pratico guardaroba accoglie giacche e cappotti e si adatta alla perfezione ai locali stretti e ai corridoi. È ideale per rendere fruibili anche gli spazi più angusti.*

*På den måde bringer vi køkken og bolig tættere på hinanden. Den praktiske knagerække giver plads til jakker og frakker – og passer perfekt i små rum eller gange. Også fremragende til nicher for at udnytte den tilgængelige plads bedst muligt.*

## SISTEMÁTICAMENTE BLANCA

*Es mucho más sencillo de lo que nos imaginamos. Cuando el blanco es el protagonista principal, el resto del elenco se adapta. En armonía con los colores claros y suaves o con los tonos madera, el blanco se reserva todo el protagonismo.*

## BIANCA E COERENTE

*È meno complicato di quanto si pensi! Se il bianco la fa da protagonista, la composizione lo segue con naturalezza. Con l'armonia dei colori chiari e delicati o le tonalità del legno, il bianco rimane sempre al centro dell'attenzione.*

## KONSEKVENT HVID

*Det er mindre kompliceret, end du tror! Når hvid spiller hovedrollen, tilpasser resten af aktørerne sig nemt. Harmonisk kombineret med lyse, bløde farver eller trætoner vil hvid helt sikkert tiltrække al opmærksomheden.*





## HARMONIOUS CALM & ELEGANT

This kitchen fits your life. The warm cashmere shade corresponds perfectly with the mysterious black and shows impressively how noble and harmonious contrasts can be. Different widths for pull-outs and cabinets create an exciting overall picture. Modern kitchen design with a clever concept.

### ARMONIOSA TRANQUILA Y ELEGANTE

*Esta cocina encaja con su vida. La calidez del tono cachemir cuadra a la perfección con el misterio del color negro y muestra lo distinguidos y armoniosos que pueden llegar a ser los contrastes. La anchura distinta de los módulos extraíbles y de los armarios aporta un toque sugerente al conjunto. Diseño de cocina moderno con un enfoque inteligente.*

### ARMONIOSA CALMA ED ELEGANTE

*Questa cucina si adatta al nostro stile di vita. La calda tonalità cashmere si sposa perfettamente con il nero misterioso e dimostra inequivocabilmente quanto raffinati e armoniosi possano essere i contrasti. Le diverse larghezze di cassetti e mobili formano un quadro d'insieme emozionante, per un design moderno e un'impostazione ben studiata.*

### HARMONISK ROLIGT & ELEGANT

*Dette køkken passer til dit liv. Den varme kashmir farvetone korresponderer perfekt med en hemmelighedsfuld sort og understreger med stor tydelighed, hvor elegant og harmonisk kontraster kan virke. Forskellige bredder af skuffer og skabe sørger for et spændingsfyldt helhedsindtryk. Moderne køkkendesign med et gennemtænkt og smart koncept.*

 UNO-GL Cashmere | Cachemir | Cachemire | Kasmir

 UNO-GL Black | Negro | Nero | Sort





THE ERGONOMICALLY THOUGHT-OUT ARRANGEMENT AND COMFORTABLE WORKING HEIGHT ARE A BOON WHEN COOKING AND SERVING. WE CALL IT A SUCCESSFUL SYMBIOSIS OF FORM AND FUNCTION. ENJOY LIFE CAREFREE AND INSPIRED - WE WELCOME YOU TO YOUR NEW KITCHEN!

*Una disposición basada en la ergonomía y una altura de trabajo cómoda siempre son de agradecer cuando se cocina o se sirven los platos. Nosotros lo llamamos la simbiosis perfecta entre forma y función. Disfrute de la vida con serenidad y déjese llevar por la inspiración: le damos la bienvenida a su nueva cocina.*

*La disposizione ergonomica ben studiata e la confortevole altezza dei piani di lavoro significano benessere e comodità per cucinare e preparare. Possiamo definirla una simbiosi perfetta di forma e funzione. Per godersi una vita ispirata e spensierata: benvenuti nella vostra nuova cucina!*

*Den ergonomisk gennemtænkte indretning og komfortable bordhøjde er en god løsning ved madlavning og anretning. Vi kalder det en vellykket symbiose af form og funktion. Ubesværet og inspireret livsnydelse – vi byder dig velkommen – men i dit nye køkken!*

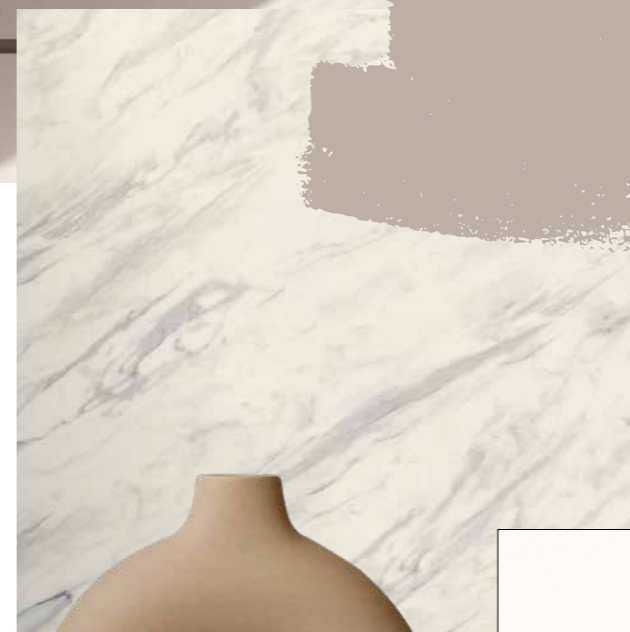

**108**  
PerfectSense®

**WORKTOP**  
Encimera  
Piano di lavoro  
Bordplade

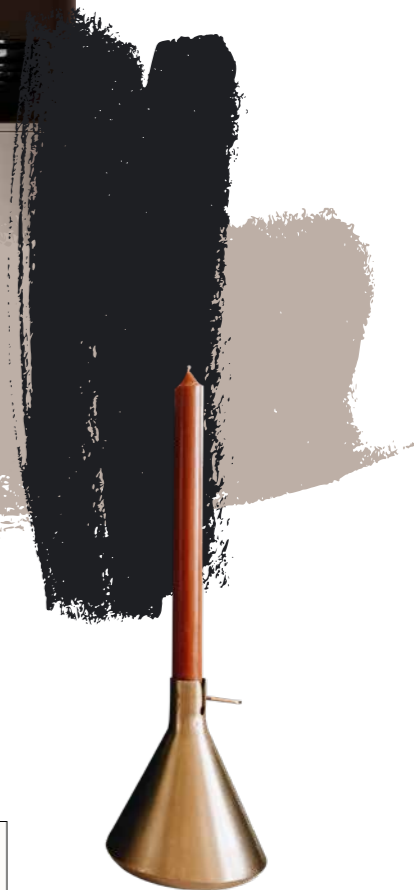



## IDEAL IMAGINATIVE AND SMART

Strong interplay: Close to nature and fresh while elegant and stylish. Perfectly staged in light oak and graphite colours. A comfortable kitchen with all the refinements – precisely composed from top to bottom, with ample storage space and modern equipment. Wardrobe, sideboard and dining area included.

### EJEMPLAR LLENO DE IDEAS & INTELIGENTE

*Fuerte interacción: Cercana a la naturaleza, fresca y al mismo tiempo elegante y con estilo. Perfectamente escenificado en los colores roble elegante luminoso y grafito. Una cocina confortable con todos los refinamientos - bien compuesta de arriba abajo, con suficiente espacio para almacenar y un moderno equipamiento. Armario ropero, aparador y plaza para comer incluidos.*

### IDEALE INTELLIGENZA E IMMAGINAZIONE

*Un'efficace interazione: naturale e fresca, ma allo stesso tempo elegante e con stile. L'ambientazione è ideale grazie alle tonalità chiare di rovere fino e grafite. Una cucina confortevole dotata di tutti gli optional, progettata con cura in ogni dettaglio, con spazio in abbondanza e dotazioni moderne, inclusi guardaroba, credenza e zona pranzo.*

### EKSEMPLARISK FANTASIFULD & KLOG

*Stærkt samspil: Tæt på naturen, frisk og samtidig elegant og stilfuld. Perfekt iscenesat i farverne lys eg og grafit. Et komfortabelt køkken gennemtænkt fra top til bund, med tilstrækkelig opbevaringsplads og moderne udstyr. Klædeskab, skænk og spiseplads er inkluderet.*

**MONTREAL-GL** Light fine oak effect | Roble fino luminoso repro. | Effetto rovere fine chiaro | Lys eg effekt  
PerfectSense®

**TOP SOFT** Graphite | Grafito | Grafite | Graphite  
TOUCHfree





## SURPRISINGLY DIFFERENT

The wardrobe is a real gem. On one side, it holds an area with a coat rail and two open storage compartments. On the other hand, graphite closed cabinets offer ample storage space. An expressive piece of living room furniture with endless possibilities.

## INESPERADAMENTE DIFERENTE

*El guardarropa es una auténtica joya. En un lado se encuentra la barra para colgar la ropa, así como dos compartimentos abiertos. En el otro están los armarios cerrados en tono grafito con muchísimo espacio para poder guardarlo todo la mar de bien. Un mueble de la zona de la vivienda con mucha personalidad y potencial.*

## SORPRENDENTEMENTE DIVERSA

*Il guardaroba è davvero eccezionale. Da un lato è dotato di una zona a giorno con barra appendiabiti e due scomparti color legno chiaro. Dall'altro lato una zona chiusa con ante grafito è pronta ad offrire tanto spazio per tenere in ordine oggetti e indumenti. Un mobile per la zona giorno che colpisce per le infinite possibilità d'impiego.*

## OVERRASKENDE ANDERLEDES

*Klædeskabet er en ægte perle. På den ene side findes et område med en knagerække og to åbne opbevaringsrum i lyst trælook. På den anden side giver lukkede skabe i grafit masser af plads til at opbevaring. Et udtryksfuldt stuemøbel med stort potentiale.*

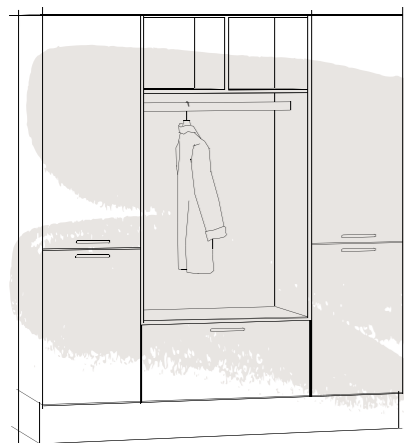



MORE OPEN SPACE TO LIVE AND ENJOY. THIS IS BEST ACHIEVED WITH AN UNCLUTTERED STYLE. CLEAR LINES, WARM COLOUR TONES AND VARIED SURFACES ARE AN ABSOLUTE MUST. GORGEOUS DESIGN WITH LIGHT FINE OAK AND GRAPHITE FRONTS, SHINY GREY TILES IN METRO STYLE, LIGHT FLOOR COVERINGS AND THE COMFORTABLE UPHOLSTERED CHAIRS WITH GREEN FABRIC UPHOLSTERY.

*Más espacio libre para vivir y disfrutar. Un estilo ordenado es lo que mejor funciona. Las líneas claras, los tonos cálidos y las superficies muy variadas no podían faltar. Este es el ejemplo perfecto con los frentes en roble fino claro y grafito, los azulejos en gris brillante tipo metro, los revestimientos claros del suelo y las cómodas sillas tapizadas con tela verde.*

*Più spazio per vivere e godere degli ambienti della casa. Con ordine e stile, grazie a linee pulite, colori caldi e superfici movimentate. Questa composizione rasenta la perfezione grazie alle ante in rovere fino chiaro e grafito, le piastrelle grigie lucide Metrostil, la tonalità chiara del pavimento e le comode sedie imbottite in tessuto verde.*

*Mere frirum til at leve og bo. Dette opnås bedst med en overskuelig stil. Klare linjer, varme farvetoner og varierede overflader er et absolut must. Her i perfekt udførelse med fronter i lys, fin eg og grafit, skinnende grå fliser i metrostil, lyse gulvbelægninger og polstrede stole med grønt stofbetræk.*







## DESIGNED PURISTIC & CREATIVE

Like a melody composed of expressive shades. Wonderfully uncomplicated and simple. The skilful interplay of putty concrete black with the warm wood shade shows a calm but grandiose combination. Let yourself be carried away into the elegant world of understatement and discover for yourself the overwhelming effect of modern design.

### DE DISEÑO PURISTA E IMAGINATIVA

*Como una melodía repleta de notas expresivas. Espléndida, simple y sin complicaciones. Es todo un acierto el modo en que el negro hormigón espátula se conjuga con el cálido tono madera para crear una combinación placida, pero grandiosa. Déjese seducir por la elegancia de la moderación y descubra el efecto arrollador del diseño moderno.*

### DESIGN PURISMO E CREATIVITÀ

*Come una melodia dai toni espressivi. Magistralmente lineare e semplice. La combinazione perfettamente riuscita di calcestruzzo spatolato in nero con la tonalità calda del legno crea una combinazione silenziosa ma fantastica. Entriamo nel modo dell'eleganza dal fascino discreto per scoprire l'effetto travolgente del design moderno.*

### DESIGN PURISTISK & KREATIVT

*Som en stærk og iørefaldende melodi. Herligt ukompliceret og stilrent. Det raffinerede samspil mellem den kølige spartelbeton sort og den varme træfarve viser en stilfærdig og alligevel storslået farvekombination. Lad dig inspirere til denne elegante verden og oplev den overvældende virkning af moderne design.*

**COMET-GL** Putty concrete black effect | Hormigón enfoscado negro repro. | Effetto calcestruzzo spatolato nero | Spatelbeton sort effekt

**TORONTO** Cognac vintage oak effect | Roble envejecido coñac repro. | Effetto rovere antico cognac | Cognac Vintage Eg effekt





BLACK AND BROWN ARE EXPRESSIVE COLOURS THAT, WHEN COMBINED, EXUDE GREAT STRENGTH AND STABILITY. NOT ONLY DOES A RESTRAINED BLUE GO WELL WITH THIS, BUT MANY OTHER MODERN COLOURS AS WELL. THIS UNDERLINES THE SIMPLE DESIGN.

*El negro y el marrón son colores expresivos que, al combinarse, irradian mucha fuerza y estabilidad. No solo les pega el azul discreto, sino también muchos más colores modernos. Todo esto también resalta la simpleza del diseño.*

*Nero e marrone sono colori espressivi, combinati tra loro irradiano grande forza e stabilità. Vi si abbina a perfezione tanto un sobrio blu quanto tanti altri colori moderni. Un abbinamento che sottolinea ancora di più la semplicità del design.*

*Sort og brun er udtrykfulde farver, som i forening udstråler styrke og stabilitet. Ikke kun en dæmpet blå, men også mange andre moderne farver passer fremragende til denne kombination. De understreger det enkle design yderligere.*

## SlightLift

↑ slide ↗ lift ☀ lights on

The SlightLift wall unit impresses with its unusual appearance in combination with atmospheric lighting technology. Whether it is used as a closed wall unit or open as a decorative shelf: it is always an eye-catcher.

The word creation SlightLift is a combination of the words „Slide“, „Light“ and „Lift“ and describes the essential wall unit features: sliders, flaps and intelligent lighting control.



### SLIGHTLIFT

*El armario suspendido SlightLift convence con un diseño único que se aúna con una técnica de iluminación lograda. Ya sea de forma cerrada como armario suspendido o abierto como estantería decorativa: en cualquier de los casos llamará la atención.*

*El nombre SlightLift se compone de los términos ingleses «Slide», «Light» y «Lift» que describen las características principales de este mueble: deslizable, abatible y con un control de iluminación inteligente.*

### SLIGHTLIFT

*Il pensile SlightLift, con la sua straordinaria estetica unita a suggestivi effetti di luce offre tanti argomenti per farsi scegliere: come pensile chiuso o elemento a giorno come oggetto d'arredo, sa catturare sempre lo sguardo di tutti.*

*Il nome d'arte SlightLift è una combinazione delle parole "Slide", "Light" e "Lift" che sintetizzano le sue caratteristiche essenziali: movimento, chiusura e controllo intelligente della luce.*

### SLIGHTLIFT

*SlightLift overskabet imponerer med en usædvanlig optik i kombination med en stemningsfyldt lys teknik. Uanset om lukket som overskab eller åben som en dekorativ reel: I alle*

*tilfælde vækker det opmærksomhed. Kunstnavnet SlightLift er sammensat af ordene „Slide“, „Light“ og „Lift“ og dækker skabets væsentligste egenskaber: Skubbe, vippe og den intelligente lysstyring.*



## MINIMALIST EXCELLENT & BOLD

Applause for shapes and contours. And for an expressive play with light and shadow. A black kitchen in perfection. The grande dame in your interior - understated and spectacular at the same time. The black fronts and surfaces plus docked cooking and sink area provide the grand appearance. And show all their skills in the interplay with wood.

### MINIMALISTA AUDAZ Y EXCELENTE

*Un aplauso para las formas y los contornos. También para el juego de luces y sombras tan expresivo. Esta cocina de color negro encarna la perfección. La gran dama en sus dominios, discreta y espectacular por igual. Los frentes y las superficies de color negro, así como la zona de cocción y lavado acoplada también influyen en la gran puesta en escena. La interacción con la madera permite demostrar todo de lo que son capaces.*

### MINIMALISTA ECCELLENTE E AUDACE

*Un applauso speciale per le forme ed il lineamenti. E per il giuoco di luci ed ombre. Una cucina nera nella sua forma più perfetta. La grande protagonista del vostro arredamento, discreta e al tempo stesso spettacolare. Le ante e le superfici nere come anche le anesse zone cottura e lavaggio completano lo spettacolo. E con le essenze legno fanno vedere di cosa sono capaci.*

### MINIMALISTISK EXCELLENT & NØGTERNT

*Stort bifald til former og konturer. Og til et udtrykstærkt spil med lys og skygge. Et fuldendt sort køkken. Fornemt tilbageholdende og spektakulær på samme tid. De sorte fronter og overflader plus det integrerede koge- og opvaskeområde skaber en imponerende virkning. Som viser sit fulde potentiale i samspil med træ.*



**PERFECT SOFT** Black | Negro | Nero | Sort  
PerfectSense®



SHOWTIME FOR BLACK. THIS KITCHEN IS ELEGANT AND OF HIGH QUALITY IN A CONSISTENT SHADE OF BLACK. FROM THE FRONT OVER THE WORKTOP TO THE HANDLELESS RAIL. BEAUTIFUL WITH IT: ACCESSORIES AND DECORATIVE ELEMENTS IN NATURAL COLOURS AND SOFT BROWN SHADES. A CONTRAST THAT EMPHASISES AND ENHANCES BLACK. LET 'S DO IT.

*Que comience el espectáculo del color negro. El aire distinguido y sofisticado de esta cocina se debe a la continuidad del color negro. Desde el frente pasando por la encimera hasta el perfil gola. También son muy bonitos los accesorios y los elementos decorativos en colores naturales y en suaves tonos marrones. El contraste aún resalta más el color negro y lo enriquece. Let 's do it.*

*Entra in scena il nero. Raffinata e pregiata, questa cucina fa mostra di sé in una tonalità di nero ricorrente. Dalle ante al piano di lavoro, fino alla gola. E ci si abbinano alla grande gli accessori ed elementi decorativi nei colori naturali e delicate tonalità di marrone. Un contrasto che esalta ed impreziosisce ancora di più il nero. Perché no?*

*Showtime for sort. Med den gennemgående sorte farve fremstår dette køkken fornemt og elegant. Fra front og bordplade til kantlister. Smukke kontraster: Tilbehør og dekorative elementer i naturfarver og blide bruntoner. En kontrast, som fremhæver det sorte yderligere og understreger elegancen. Let 's do it.*



## PLEASANT SMART AND CAREFREE

The ideal kitchen for smaller layouts. There is a storage space in a small area and, of course, everything that belongs in a modern kitchen. The colour scheme of the cashmere and natural fine-oak fronts appears light and carefree. Clever planning allows smartly organised storage space even in small kitchens.

### **SIMPÁTICA INTELIGENTE Y DESPREOCUPADA**

*La cocina ideal para espacios pequeños. Con sitio para guardar los objetos en una superficie reducida y, por supuesto, con todos los elementos indispensables en una cocina moderna. Los colores de los frentes en cachemir y roble fino natural aportan claridad y serenidad. Un espacio de almacenamiento bien organizado también es posible en las cocinas pequeñas cuando se aplica una planificación inteligente.*

### **PIACEVOLE ELEGANTE E SPENSIERATA**

*La cucina perfetta per piccoli ambienti. Offre capienza con il minimo di ingombro, senza rinunciare a tutto quello che serve a una cucina moderna. Il color cashmere delle ante e le finiture in rovere fino naturale danno un tono chiaro e disinvolto. Con un progetto intelligente è possibile ottimizzare lo spazio anche nelle cucine più piccole.*

### **SYMPATISK SMART OG UBEKYMRET**

*Det ideelle køkken til mindre indretninger. Her er der plads til opbevaring på et lille område og selvfølgelig alt, hvad der hører til i et moderne køkken. Farveskemaet på fronterne i kashmir og naturlig fin eg er let og ubekymret. Intelligent organiseret opbevaringsplads er også mulig i små køkkener – med smart planlægning er intet umuligt.*



**TOP BRILLANT** Cashmere | Kashmir | Kashmire | Kasmir

**MONTREAL** Natural fine oak effect | Roble fino natural repro. | Effetto rovere fine naturale | Eg natur effekt  
PerfectSense®

## JUST SIMPLE, SIMPLY GOOD

Staggered cubes effectively loosen up the ambience. Black-steel frames with back panels in fine natural oak seem to float. A great way to safely store and present special items or cherished books. Design becomes a delight when kitchen and living merge.



## SIMPLEMENTE SENCILLA, SIMPLEMENTE GENIAL

Los "KUBEN" desplazados aligeran el espacio causando un gran efecto. Los marcos de acero negro con las traseras en roble fino natural parecen como si estuvieran flotando. Una ocasión estupenda para exhibir y tener bien guardados los objetos decorativos más bonitos y los libros más preciados. El diseño se convierte en una delicia cuando la cocina y la vivienda se fusionan.

## SEMPLICE E SEMPLICEMENTE GENIALE

I cubotti sfalsati sulla parete danno movimento all'ambiente. Le sottili cornici in acciaio nero e fondale in rovere fino naturale sembrano levitare. Uno speciale elemento decorativo che fa da cornice oggetti speciali o i libri preferiti. Quando cucina e zona living si fondono, il design diventa una delizia.

## ENKELT, GODT

De forskudte kuber løsner effektivt op for stemningen. De sorte stålstel med rygpaneler i fin, naturlig eg ser ud, som om de svæver. En fantastisk måde at opbevare og præsentere smukke dekorationer eller elskede bøger på. Design bliver en fryd, når køkken og stue smelter sammen.





## PERFECT SHAPES VISUALLY APPEALING AND ATTRACTIVE

Well conceived down to the last detail. Further to the special architecture of the structure and kitchen, new technology features are captivating. Like the two wardrobes with Climber, a sensor-controlled, electric glass louvre front in black colour with glass shelf. Or the LED luminaires with colour temperature control. A magnificent kitchen in velvet oak-greige with bronze-coloured fillets and niche paneling.

### CON FORMAS PERFECTAS BELLA Y ATRACTIVA

*Pensada hasta el último detalle. Aparte de la arquitectura especial del edificio y de la cocina, las nuevas características técnicas también impresionan. Como los dos armarios con Climber, un frente de laminas de vidrio en negro que se controla electricamente por sensor equipado con estantes de vidrio. O también el de las lámparas LED con control de la temperatura del color. Una cocina magnífica en roble terciopelo greige con perfiles gola en bronce y revestimiento en el entrepaño.*

### FORME PERFETTE BELLA E ATTRAENTE

*Studiata nei minimi dettagli. Oltre all'architettura particolare della cucina e dell'edificio, incantano le tante e nuove funzionalità tecniche. Come i due sopralzi Climber con serrandina in vetro nero, apertura elettronica con sensore e ripiani in vetro. Oppure l'illuminazione a LED con regolazione di intensità e gradazione di colore. Una cucina splendida in rovere velluto grigio-beige con gole e schienale color bronzo.*

### FORMFULDENDT ÆSTETISK OG ATTRAKTIV

*Gennemtænkt ned til mindste detalje. Udover bygningens og køkkenets særlige arkitektur, fængsler de nye teknologiske funktioner. Som for eksempel to garderober med Climber, en sensorstyret elektrisk glaslamelfront i sort med glashylde. Eller LED-armaturer med farvetemperaturstyring. Et storslået køkken i fløjsagtig egegrå med bronzefarvede lister og nichepaneler.*



**CALGARY-GL** Greige velvet oak effect | Roble seda greige repro. | Effetto rovere velluto grigio-beige | Grå bøg effekt  
PerfectSense®

**UNO** Graphite | Grafito | Grafite | Graphite



## A PERFECT PAIR

Velvet oak-greige and graphite colours create cosiness. Shades reinforce each other and boost their effect. Bronze-coloured elements cleverly loosen them up. The dark wardrobe is classy and transforms every entrance into a special access area. What more do you need to realise your comfort zones?



### LA PAREJA PERFECTA

*El roble terciopelo greige y el grafito son colores que dan sensación de comodidad. Cada tono produce un efecto en el otro. Los elementos bronce son una variación muy acertada. El guardarropa oscuro es distinguido y convierte el recibidor en un espacio muy especial. ¿Qué más se necesita para que las zonas de confort propias se hagan realidad?*

### UNA COPPIA PERFETTA

*Le tonalità del rovere greige vellutato e della grafite creano un ambiente accogliente. Ciascuna tonalità mette in risalto l'altra. Gli elementi color bronzo le movimentano con maestria. L'armadio scuro è raffinato e trasforma ogni ingresso in un ambiente speciale. Che altro occorre per realizzare le proprie comfort zone?*

### DET PERFEKTE PAR

*Farverne velvet oak-greige og grafit skaber hygge. Hver nuance tillader den anden at bevare sin egen effekt. Bronzefarvede elementer gør dem mindre højtidelige på en smart måde. Den mørke garderobe er stilfuld og forvandler enhver entré til et særligt indgangsparti. Hvad mere behøver du for at realisere dine komfortzoner?*







## CHARMING ROMANTIC & COSY

Charmingly bright and friendly, like a beautiful summer's day - this kitchen impresses with casual cosiness. The white cabinet and drawer fronts give this kitchen design a high degree of lightness. The worktop in fine light oak is a perfect match. A beautiful contrast: the handles are in anthracite.

### ENCANTADORA ROMÁNTICA Y ACOGEDORA

*Tan luminosa, agradable y sugerente como un hermoso día de verano. Esta cocina seduce con su confort relajado. Los frentes enmarcados en blanco confieren un aspecto muy liviano a todo el conjunto. La encimera en roble noble claro combina a las mil maravillas y los tiradores en antracita forman un contraste muy bello.*

### AFFASCINANTE ROMANTICA E ACCOGLIENTE

*Incantevole, luminosa e accogliente come una bellissima giornata d'estate: questa cucina colpisce per il suo confortevole stile casual. Le bianche ante a telaio danno a questa composizione una particolare leggerezza. Il top in rovere fino chiaro ci si adatta perfettamente. Una bellissima nota di contrasto: le maniglie color antracite.*

### CHARMERENDE ROMANTISK OG HYGGLIGT

*Fortryllende hvid og ventlig som en varm sommerdag - køkkenet overbeviser med den løslupne hygge. De hvide kassettefronter giver designet en høj grad af lethed. Bordpladen er i lys og fin eg og passer optimalt. Grebene i antracit giver en skøn kontrast.*



**TOSKANA** Crystal white | Blanco cristalino | Bianco cristallo | Krystal Hvid





## OPTIMISTIC GENTLE AND QUIET

Delicate pastel shades shine in a new good-mood combination. Just what's needed to put a smile on your face every day. The fronts in powdery amaranth and discreet greige play in the same league with the light terrazzo worktop. Special highlight: The roller shutter cabinet installed at the front with black tinted glass.

### OPTIMISTA SUAVE Y SILENCIOSA

*Los suaves tonos pastel se revelan en una combinación totalmente nueva que alegra el ánimo. La vista perfecta que cada día le pondrá una sonrisa en el rostro. Los frentes en amaranto mate y la discreción del greige juegan en la misma liga que la encimera de terrazzo claro. Un protagonista especial: el armario de persiana en la parte frontal con cristal tintado en negro.*

### OTTIMISTA DELICATA E TRANQUILLA

*Delicati toni pastello in una nuova combinazione che mette di buonumore. È quello che ci vuole per illuminare il viso ogni giorno con un sorriso. Le ante in farinoso amaranth e sobrio grigio-beige armonizzano alla perfezione con il top in finitura Terrazzo chiaro. Un tocco particolare: la serrandina in vetro nero in posizione laterale.*

### OPTIMISTISK VARMT OG DELIKAT

*Sarte pastelfarver i en ny kombination af godt humør. Lige til at få smilet frem i hverdagen. Fronterne i pudderfarvet amaranth og afdæmpet greige harmonerer perfekt med den lyse terrazzobordplade. Et særligt højdepunkt: skab med jalousilåge i sort tonet glas.*

**SCALA** Amaranth | Amaranto | Amaranto | Amarant

**SCALA** Greige | Greige | Grigio-beige | Grå





EYE-CATCHING YET DISCREET: KITCHEN AND UTILITY ROOM CAST FROM A SINGLE MOULD. THE FOCUS HERE IS ON FUNCTIONALITY AND ERGONOMIC WORKING. SHORT DISTANCES, EFFICIENT WORKFLOWS AND PLENTY OF STORAGE SPACE INCLUDED. PRACTICAL: THE LARGE, HALF-OPEN PULL-OUTS FOR LAUNDRY BASKETS.

*Atractiva y discreta: la cocina y la zona de lavado es como si salieran de un mismo molde. La funcionalidad y la ergonomía para trabajar son lo más importante aquí. Las distancias cortas, la eficiencia en el trabajo y una gran capacidad de almacenaje están incluidas. Muy prácticas: las grandes gavetas semiabiertas para las cestas de la ropa.*

*Bella e sobria: cucina con lavanderia come da un unico stampo. Funzionalità ed ergonomia la fanno da protagoniste con percorsi brevi, cicli di lavoro efficienti e tanto spazio utile a disposizione. Un dettaglio di grande praticità: i capienti cestoni semiaperti per smistamento panni.*

*Æstetisk og tilbageholdende: køkken og bryggers i samme stil. Her er fokus på funktionalitet og ergonomisk arbejde. Korte afstande, effektive arbejdsgange og masser af opbevaringsplads er inkluderet. Praktisk: de store udtræk til vasketøjskurve.*

41

**WORKTOP**  
Encimera  
Piano di lavoro  
Bordplade



485

**HANDLE**  
Tirador  
Maniglia  
Greb



## CONSISTENT WARM & CALM

The muted graphite shade of the kitchen fronts in combination with the grained wood gives the furniture a frame that pleasantly emphasises the shapes. It enables a powerful calm to unfold unhindered and visual tranquillity to radiate its magic. Experience a cosy, harmoniously coordinated kitchen that affects.

### RESISTENTE CÁLIDA Y TRANQUILA

*El tono apagado del grafito en los frentes de cocina se combina con la madera veteada para enmarcar los muebles de un modo muy bello que resalta las formas. De este modo, la calma poderosa se revela sin obstáculos y el reposo visual hace su magia. Disfrute de una cocina acogedora, armoniosa y conjuntada que no deja indiferente.*

### COSTANZA CALORE E TRANQUILLITÀ

*Le tonalità attutite della grafite delle ante della cucina si unisce alle venature del legno conferiscono ai mobili una cornice che ne sottolinea piacevolmente le forme. Con fluidità viene a crearsi un silenzio profondo e l'estetica tranquilla esercita la sua magia. Una cucina accogliente e armoniosa che accarezza lo spirito.*

### VEDVARENDE VARMT & ROLIGT

*Køkkenfronternes dæmpede grafittoner i forbindelse med det årede træ giver møblerne en ramme, som diskret understreger deres form. Her kan stilheden udfolde sig uforstyrret i al sin kraft, og den optiske ro kan vise sin magi. Oplev et hyggeligt, harmonisk afstemt køkken, som vækker varme følelser.*





## BALANCED BRIGHT & CHEERFUL

A real fountain of youth and a classic at the same time. White never goes out of fashion and always looks fresh and optimistic. The black seating and the open, black shelves are an ideal counterpart and emphasise the linear details even more. The warm wall and floor colours provide additional character.

### EQUILIBRADA RADIANTE Y VIVAZ

*Una auténtica fuente de la juventud y, al mismo tiempo, todo un clásico. El blanco nunca pasa de moda y siempre es garantía de frescor y optimismo. El asiento negro y los estantes abiertos de color negro son el contrapunto perfecto y todavía realzan más los detalles rectos. Los colores cálidos de la pared y del suelo aportan más carácter al conjunto.*

### EQUILIBRIO RADIOSA E ALLEGRA

*La vera fonte della giovinezza e un vero classico allo stesso tempo. Il bianco non va mai fuori moda e ha sempre un effetto di freschezza e ottimismo. La seduta in essenza legno e gli scaffali a giorno neri sono l'ideale contrappeso che accentua ancora più intensamente la linearità dei dettagli. I colori caldi delle pareti e del pavimento danno ancora più carattere alla composizione.*

### I BALANCE STRÅLENDE & MUNTER

*En sand kilde til ungdom og klassiker på samme tid. Hvidt går aldrig af mode og virker altid frisk og optimistisk. Siddepladsen i sort og de åbne sorte reoler er det ideelle modstykke og fremhæver den enkle linjeføring endnu mere. De varme væg- og gulvfarver giver yderligere karakter.*

 **MURANO BRILLANT-GL** Crystal white | Blanco cristalino | Bianco cristallo | Krystal Hvid



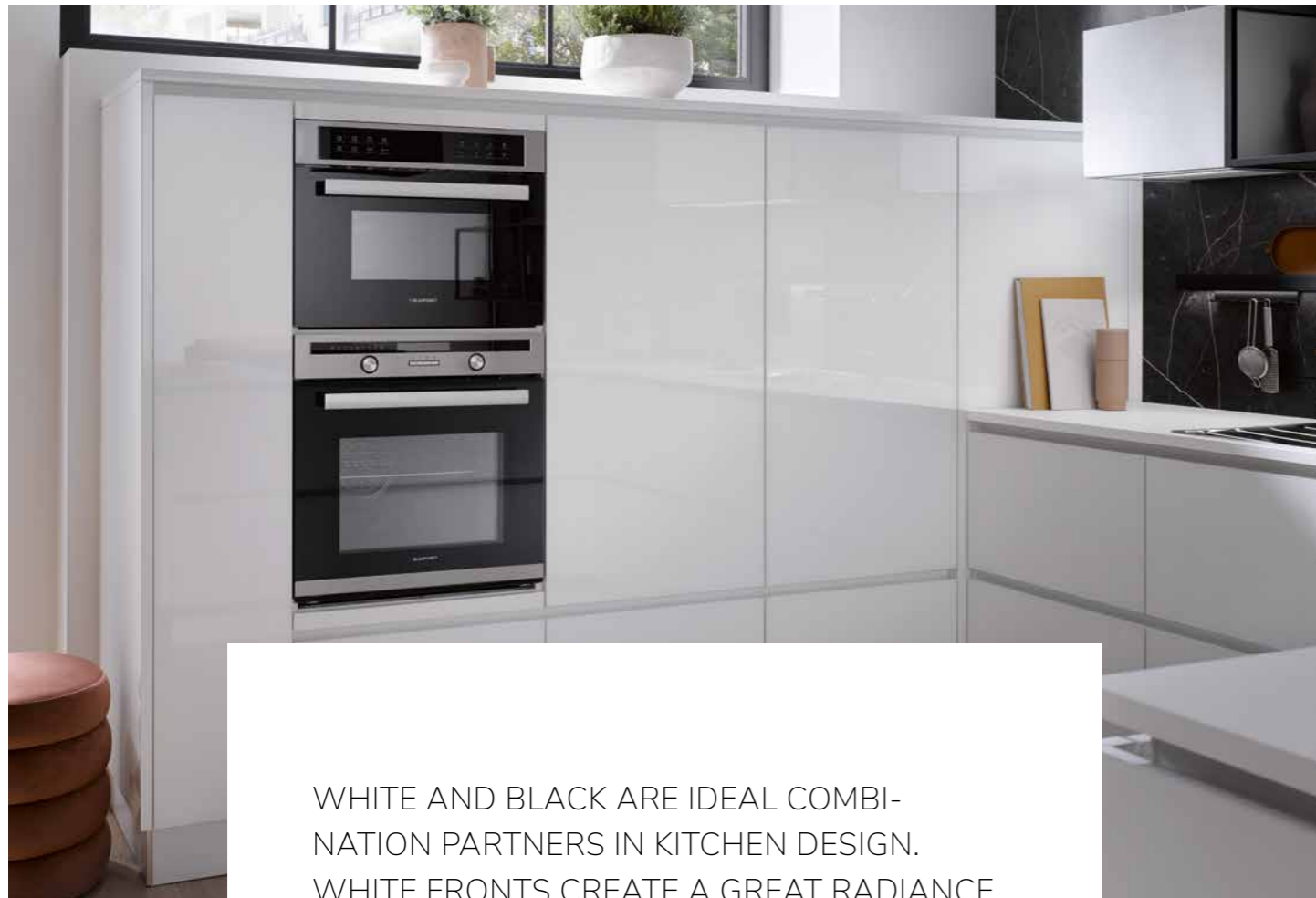

WHITE AND BLACK ARE IDEAL COMBINATION PARTNERS IN KITCHEN DESIGN. WHITE FRONTS CREATE A GREAT RADIANCE AND MAKE ROOMS APPEAR MORE SPACIOUS. INTERESTING EFFECTS ARE PROVIDED BY SKILFULLY USED BLACK SHADES, SUCH AS ON THE BREAKFAST BAR OR THE WALL BEHIND THE SINK.

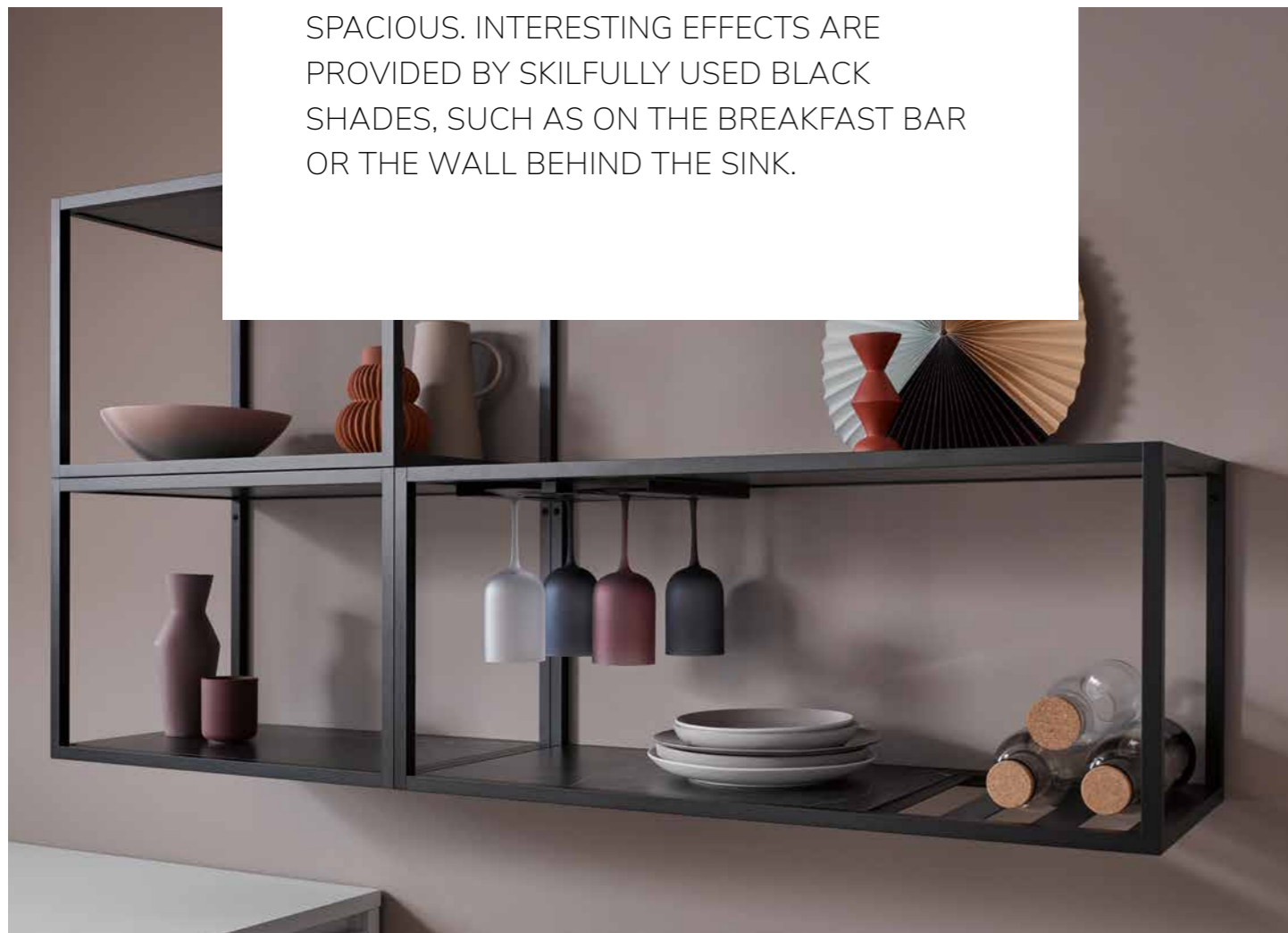

*El blanco y el negro forman un tándem ganador en el diseño de cocinas. Los frentes de color blanco tienen mucho carisma y consiguen que las estancias parezcan más espaciaosas. Usar bien los tonos negros crea efectos interesantes como se aprecia en la barra de la cocina o en la pared detrás del fregadero.*

*Bianco e nero sono partner ideali nella progettazione della cucina. Le ante bianche danno luminosità e amplificano la sensazione spaziale. Il sapiente inserimento dei toni neri creano effetti interessanti, come nel bancone della cucina o sulla parete dietro il lavello.*

*Hvidt og sort er de ideelle kombinationspartnere i køkkenindretning. Hvide fronter har en stærk udstråling og får rummene til at virke større. Velovervejede sorte kontraster giver interessante effekter, som f.eks. køkkenbordet eller væggen bag køkkenvasken.*



## SPECIAL INNOCENT & IMAGINATIVE

Ergonomic, functional and yet so homely. An open kitchen that offers everything. The satin-coloured fronts complement the dark graphite colour perfectly and give an impressive demonstration that light and dark are perfect partners. The integrated mini-office in the white block is ideal for small office tasks. A dream pair with great details.

### ESPECIALMENTE INOCENTE E IMAGINATIVA

*Ergonómica y funcional, pero también muy agradable. Una cocina abierta que lo ofrece todo. Los frentes de color satén son el complemento perfecto para el tono oscuro del grafito e ilustran magníficamente lo bien que se llevan las tonalidades claras con las oscuras. El minidespacho integrado en el bloque blanco es idóneo para realizar pequeñas tareas de oficina. Una pareja ideal con detalles increíbles.*

### SPECIALE INNOCENTE E FANTASIOSA

*Ergonomica, funzionale e tuttavia assolutamente accogliente. Una cucina aperta che offre tutto. Le superfici satiniate si integrano perfettamente con la scura tonalità grafito e dimostrano con tutta evidenza come chiaro e scuro stiano perfettamente bene insieme. La piccola postazione di lavoro integrata nel blocco bianco è ideale per lo smart-working. Una coppia da sogno con dettagli da sogno.*

### NOGET GANSKE SÆRLIGT USKYLDIGT & OPFINDSOMT

*Ergonomisk, funktionelt og alligevel hyggeligt. Et åbent køkken, som har det hele. De satinfarvede fronter passer fremragende sammen med den mørke farvetone grafit og viser virkningsfuldt, at lyst og mørkt er de perfekte partnere. Det integrerede mini-office i den hvide blok er optimalt egnet til små kontoropgaver. Et drømmepar med flotte detaljer.*

**PERFECT SOFT-GL** Graphite | Grafito | Grafite | Grafit  
PerfectSense®

**PERFECT SOFT** Taupe | Satén | Satin | Satin  
PerfectSense®





## IMPRESSIVE SELF-ASSURED & ENERGETIC

Brushed steel and black take a clear position. Together they set the tone and appear determined and proud. The wooden shades of the table, floor and wall form a beautiful contrast. The dark shades have the great power of steel and an intense effect. They give the room a refined atmosphere and provide the optimal stage for the minimalist shelves.

### IMPRESIONANTE LLENA DE DETERMINACIÓN Y ENERGÍA

*El acero cepillado y el negro ocupan una posición muy clara. Cuando se combinan, marcan el paso con aspecto decidido e imponente. Los tonos madera presentes en la mesa, el suelo y la pared forman un contraste muy bello. Los tonos oscuros derrochan personalidad y aportan intensidad. Dan un aire sofisticado a la estancia y hacen que los estantes minimalistas despierten con nota.*

### SUGGESTIVA ENERGETICA E SICURA DI SÉ

*Acciaio spazzolato e nero esprimono una posizione chiara. Insieme, danno il tono all'ambiente con un effetto deciso e fiero. Le essenze legno del tavolo, pavimento e pareti creano un gradevole contrasto. Le tonalità scure appaiono forti e intense. Donano allo spazio un'atmosfera raffinata ed esaltano a perfezione gli scaffali minimalisti.*

### IMPONERENDE SELVSIKKER & ENERGISK

*Børstet stål og sort giver klare linjer. I fællesskab giver de elegance og virker beslutsomme og stolte. Bordets, gulvets og væggenes træfarver danner en smuk kontrast. De mørke farvetoner har et stærkt udtryk og virker intensive. De giver rummet en raffineret stemning og iscenesætter de minimalistiske reoler optimalt.*



**METEOR** Brushed steel effect | Acero cepillado repro. | Effetto acciaio spazzolato | Børstet stål effekt





**375**

**HANDLE**

Tirador  
Maniglia  
Greb



**111**

PerfectSense®

**WORKTOP**

Encimera  
Piano di lavoro  
Bordplade

## TAKING OVER THE SUPPORTING ROLE

The black of the side panels and worktop is repeated in the wall colour and on the shelves. The matt black metal catches the light with a mysterious shimmer. The new, filigree metal shelves are not only visual highlights - their speciality: they are first and foremost simply practical. Plenty of storage space for all things needed for cooking, baking and serving, designed openly. They offer quick access to utensils and food..



## ASUME EL PAPEL PRINCIPAL

*El negro de los costados laterales y la encimera se repite en el color de la pared y los estantes. El metal negro mate captura la luz y brilla con un aire de misterio. Las nuevas estanterías metálicas de filigrana no solo destacan por su aspecto visual, ya que ante todo están pensadas para ser prácticas. Espacio abundante para guardar todo lo necesario para cocinar, hornear y servir. Su diseño abierto permite tener siempre a mano los utensilios y los ingredientes.*

## UN RUOLO DA PROTAGONISTA

*Il nero dei fianchi e del top viene richiamato dal colore della parete e degli scaffali. Il metallo nero opaco cattura la luce e misteriosamente scintillando la diffonde. I nuovi e filigranati scaffali in metallo non sono solo un elemento estetico: sono soprattutto e semplicemente pratici. C'è spazio in abbondanza per tutto quello che serve per cucinare, per il forno per preparare. Essendo a giorno, consentono di avere a portata di mano utensili e alimenti.*

## DEN FØRENDE ROLLE

*Den sorte farve på sidevanger og bordplade gentages i vægfarven og i reolerne. Det matsorte metal fanger lyset og skinner. De nye, spinkle metalreoler er ikke kun optiske highlights - deres formål er primært at være praktiske. Meget opbevaringsplads til alle de ting, der bruges til madlavning, bagning og servering. Den åbne form giver hurtig adgang til køkkenredskaber og madvarer.*





## SOOTHING RELAXED & GENTLE

Light colours, such as crema-magnolia and the friendly wood shade, make for a soothing combination. The guarantee for a good start to the day. The subtle colours of the kitchen furniture as well as the walls and floor skilfully emphasise this calm look. All shades belong together and form a unit.

### RECONFORTANTE DESENFADADA Y RELAJANTE

*Los colores claros, como el magnolia crema y el agradable tono madera, forman una combinación que desprende serenidad. La mejor garantía de que el día empieza con buen pie. Los colores discretos de los muebles de la cocina, así como de la pared y el suelo, destacan muy bien el look tranquilo. Todos los tonos hacen juego y forman una unidad.*

### PIACEVOLE RILASSANTE E DELICATA

*I colori chiari, come il crema magnolia e l'amichevole presenza del legno, creano una combinazione di grande rilassatezza. Una garanzia per cominciare bene la giornata. I colori sobri dei mobili, della parete e del pavimento sottolineano sapientemente la tranquillità della composizione. Tutte le tonalità si fondono in un unico armonioso insieme.*

### VELGØRENDE AFSLAPPET & BLIDT

*Lyse farver som Crème -magnolie og venlige træfarver giver en afslappet kombination. Din garanti for en god start på dagen. Køkkenelementernes smagfulde diskrete farvespil og farverne på vægge og gulv understreger på raffineret vis dette rolige look. Alle farvetoner hører sammen og skaber en helhed.*

**LASER BRILLANT** Crema-magnolia | Crema-magnolia | Crema-magnolia | Crème-magnolie





## SELF-CONFIDENT COMMITTED & MOTIVATED

Mattes loves wood. This also applies to Ravenna Black. This is where cosiness and modern kitchen design meet. The use of different colours, surfaces and structures creates a really lively tension. The glass fronts in the wall units produce shining accents. A stylish mix.

### SEGURA DE SÍ MISMA CON COMPROMISO Y MOTIVACIÓN

*Al mate le gusta la madera. Lo mismo puede decirse del negro Ravenna. Aquí se dan la mano la comodidad con el diseño de cocina moderno. El uso de diferentes colores, superficies y estructuras crea una tensión asombrosamente viva. El contraste se marca con el brillo de los frentes de cristal de los armarios de pared. Una mezcla que marca estilo con paso seguro.*

### SICURA DI SÈ IMPEGNATA E MOTIVATA

*All'opaco piace il legno. Niente di più vero anche per il modello Ravenna in nero. Qui il comfort incontra il design moderno in cucina. L'impiego di colori, superfici e strutture diversi crea un'emozione estremamente vivace. Le ante in vetro dei pensili donano un tocco di brillantezza. Un mix dallo stile sicuro di sé.*

### SELVSIKKER ENGAGERET & MOTIVERET

*Mat magnolietræ. Dette gælder også for Ravenna sort. Her mødes hygge med moderne køkken-design. De forskellige farver, overflader og strukturer skaber en yderst levende forventning. Overskabenes glasfronter skaber skinnende blanke detaljer. Et stilsikkert mix.*



**RAVENNA** Black | Negro | Nero | Sort



## INVITING HARMONIOUS AND SOPHISTICATED

Amaranth, the trendy tone. Not only in the kitchen but also in the living area. Thus, the sideboard is also a fascinating eye-catcher that nevertheless emanates calm and comfort. Its special tone is further enhanced when combined with kitchen elements in black velvet oak. The ideal kitchen for those leading a young and modern lifestyle.

### ACOGEDORA ARMONIOSA Y CULTIVADA

*Amaranto, un color de tendencia. No solo en la cocina, sino también en la zona del salón. El aparador también es un fascinante punto de atracción, que sin embargo transmite calma e y confort. Este tono especial gana aún más poder de atracción en combinación con los elementos de la cocina en roble terciopelo negro. La cocina ideal para todas las personas con ganas de vivir una vida juvenil y moderna.*

### INVITANTE ARMONIOSA E RAFFINATA

*Amaranto, un colore di tendenza. E non solo in cucina, ma anche in soggiorno. La credenza colpisce per il suo fascino che irradia tranquillità e crea atmosfera. Combinata con gli altri elementi della cucina in rovere velluto nero, questa particolare tonalità risulta ancora più ricca di fascino. È la cucina ideale per chi ama abitare con stile giovane e moderno.*

### INDBYDENDE HARMONISK OG KULTIVERET

*Amaranth, en farve i trend. Ikke kun til køkkenet, men også til opholdsstuen. Derfor bliver skænken også til et fascinerende blikfang, der samtidig udstråler ro og komfort. I kombination med køkkenelementerne i mat sort eg bliver den særlige farvetone endnu mere attraktiv. Et ideelt køkken til alle, der gerne vil bo moderne.*

**CALGARY** Black velvet oak effect | Roble seda negro repro. | Effetto rovere velluto nero | Sort bøg effekt  
PerfectSense®

**SCALA** Amaranth | Amaranto | Amaranto | Amarant





FINELY COORDINATED, WARM COLOURS FOR THE SURROUNDINGS AND SELECTED DECORATIONS CREATE A SPECIAL FLAIR. THE SIDEBOARD AND WARDROBE ARE IDEALLY POSITIONED AND OFFER AMPLE SPACE. CREATING INVITING ROOMS WITH A CHEERFUL ATMOSPHERE IS EASY WITH THE RIGHT LIVING ROOM FURNITURE AND ACCESSORIES.

*Los colores cálidos y perfectamente combinados con el entorno y la decoración selecta aportan un encanto especial. El aparador y el guardarropa ocupan la posición ideal y ofrecen una gran cantidad de espacio. Crear estancias acogedoras y con un ambiente más sereno es muy fácil con el mobiliario del hogar y los accesorios adecuados.*

*I colori caldi finemente coordinati e la decorazione studiata con cura creano un ambiente davvero speciale. Credenza e guardarropa sono disposti in modo ideale e mettono a disposizione spazio a volontà. Con i mobili e gli accessori giusti è facile realizzare spazi invitanti dall'atmosfera allegra e creativa.*

*Fint afstemte, varme farver til omgivelserne og udvalgte dekorationer skaber en særlig stemning. Skænken og klædeskabet er ideelt placeret og sikrer masser af plads. Med de rigtige stuemøbler og tilbehør er det nemt at skabe indbydende rum med en god atmosfære.*





## SOLID PRESENT & AUTHENTIC

A successful trio. The clear look of the graphite-coloured kitchen fronts with glass surface is repeated in the adjoining work area and is invitingly taken up by the dark wood of the tabletop. This is where different areas of life meet and complement each other perfectly. Cook, work and eat in one room. Appetising, the wood-coloured worktop.

### SÓLIDA AUTÉNTICA Y CON PRESENCIA

*Una tríada bien lograda. La fisonomía clara de los frentes de cocina en color grafito con superficie de cristal se repite en la zona de trabajo aneja, donde la madera oscura del tablero de la mesa retoma este aspecto acogedor. Aquí se juntan diversas esferas de la vida que se complementan a la perfección. Cocinar, trabajar y comer en una misma estancia. El color madera de la encimera despierta el apetito.*

### SOLIDITÀ AUTENTICITÀ E PRESENZA

*Un accordo ben riuscito. L'aspetto chiaro dei frontali color grafito con superficie in vetro si ripete nella zona di lavoro annessa ed è ripreso in modo invitante dal legno scuro del piano del tavolo. Qui si incontrano e si completano in modo perfetto diverse zone abitative. Cucinare, lavorare e mangiare nello stesso ambiente. E il top in essenza legno stuzzica l'appetito.*

### SOLIDITET PRÆSENT & AUTENTISK

*Vellykket treklang. Den klare optik i de grafitfarvede køkkenfronter med glasoverflade gentages i det integrerede arbejdsområde og indgår i en indbydende symbiose med bordpladens mørke træ. Her mødes forskellige livsområder og supplerer hinanden optimalt. Madlavning, arbejde og spisning i samme rum. Den træfarvede bordplade virker appetitvækkende.*



MURANO SOFT Graphite | Grafito | Grafite | Grafit



## STUNNING BRIGHT & CAREFREE

A life-affirming statement piece. White in all its glory - as the universal colour for fronts and worktop. The floor-to-ceiling cabinets offer a huge amount of space and are a great partner for the back wall in wood colours with black shelves and wall units. A kitchen with well thought-out details and stylish storage space.

### **DESLUMBRANTE CLARA Y DESENFADADA**

*Un diseño que es una afirmación de la vida. El blanco en todo su esplendor es el color que recorre los frentes y la encimera. Como los armarios llegan hasta el techo proporcionan mucho espacio y quedan muy bien con la pared del fondo en colores madera y sus estanterías y armarios de pared negros. Una cocina sin ningún detalle al azar y con un espacio de almacenaje muy chic.*

### **DELIZIOSA LUMINOSA E SPENSIERATA**

*Una vera ode alla vita. Il bianco in tutto il suo splendore, modulato sia nelle ante che nel piano di lavoro. Le capienti armadiature che arrivano al soffitto offrono tanto spazio e si combinano meravigliosamente con la parete rivestita in essenza legno con vani a giorno e pensili neri. Una cucina dai dettagli studiati e dalla grande ed elegante capienza.*

### **BEVÆGENDE LYST & SORGLØST**

*Et livsbekræftende statement-piece. Hvidt i al sin pragt – som gennemgående farve på fronter og bordplade. De loftshøje skabe giver enormt meget plads og er en fin partner til køkkenets bagvæg i træfarver med de sorte reoler og overskabe. Et køkken med gennemtænkte detaljer og smarte opbevaringsrum.*

 **GRANADA** White | Blanco | Bianco | Hvid







## STIMULATING BRIGHT & CHEERFUL

An impressive kitchen with many facets. The light cream-coloured fronts as a calm anchor point in the centre stand in contrast to the steel elements in black. Exceptionally impressive - the dark tile splashback and the open brick walls. Mix & Match. Goes well with: a workstation with storage space and the separate seat.

### ESTIMULANTE ANIMADA Y VIVAZ

Una cocina impresionante con numerosas facetas. Los frentes claros de color crema son como un remanso de paz en el centro y contrastan con los elementos de acero negros. Los azulejos oscuros y las paredes de ladrillo visto dejan con la boca abierta. Combine como quiera. Queda perfecto un lugar de trabajo con espacio de almacenaje y asiento separado.

### STIMOLANTE LUMINOSA E VIVACE

Una cucina suggestiva dalle mille sfaccettature. Le ante chiare color crema al centro suggeriscono calma, in netto contrasto con gli elementi in finitura acciaio nero. Si fanno notare in modo particolare la piastrellatura scura e le pareti in mattoni grezzi. Un mix ricco di armonia. Perfettamente integrata: la postazione di lavoro con scaffalatura e seduta a parte.

### OPHIDSENDE LIVLIGT & MUNTERT

Et imponerende køkken med mange facetter. De centrale lyse cremefarvede fronter danner den rolige modpol til stålelementerne i sort. Usædvanligt virkningsfuldt – de mørke spejlfiser og de frilagte murstensvægge. Mix & match. Passende til dette: En arbejdsplads med opbevaringsrum og en separat siddeplads.

ROMA Crema-magnolia | Crema-magnolia | Crema-magnolia | Crème-magnolie





**122**  
PerfectSense®  
**WORKTOP**  
Encimera  
Piano di lavoro  
Bordplade



## OBJECTIVE NEUTRAL & RESERVED

So much for mousy grey. This kitchen in pearl grey projects a pure and elegant shine. Beautiful colour partners: wood shades and black. They give the grey fronts the right frame and lend them radiance. An ideal antithesis to our hectic everyday life. Grey is still an insider's tip in the kitchen sector, but it is more in vogue than ever.

### SOBRIA NEUTRA Y DISCRETA

*No tiene nada de mosquita muerta. Esta cocina en gris perla tiene un aspecto purista y elegante. Los bellos colores que la acompañan, los tonos madera y el negro, tampoco se quedan atrás. Son un marco que combina con los frentes grises, a los que contagian su personalidad. El contrapunto perfecto al ajetreo diario. El gris sigue siendo el truco secreto en el universo de las cocinas, aunque esté más de moda que nunca.*

### PRAGMATICA SOBRIA E RISERVATA

*Mai banale. Questa cucina grigio perla dà di sé un'immagine purista ed elegante. Partner ideali nei colori: le tonalità del legno e il nero, che fanno da degna cornice alle ante grigie e le rendono radiose. Un rifugio ideale dagli affanni della vita quotidiana. Il grigio in cucina è un suggerimento segreto ancora ben nascosto, ma di tendenza come non mai.*

### SAGLIGT NEUTRALT & TILBAGEHOLDENDE

*Ikke antydning af grå mus. Dette køkken i perlegråt udståler purisme og elegance. Smukke farvepartnere: Træfarver og sort. De danner en passende ramme for de grå fronter, så de fremstår endnu smukkere. Den ideelle modpol til vores stressede hverdag. Farven grå på køkkenområdet er stadig et insider-tip, men så trendy som aldrig før.*



## SELECTION COLOURS

Our colour range of burgundy, eucalyptus, ocean and umbra-natur, now complemented by the new colours azure and blackberry, bring lively accents to modern kitchens. All colours are coordinated in such a way that they are ideal partners for all natural and wood tones, for white as well as for black and graphite. Our range of colours are real all-rounders and welcome in kitchens.



### COLORES SELECTION

Los colores de tendencia borgoña, eucalipto, océano y umbra natura le traen a la cocina moderna acentos llenos de vida y ahora los añadimos los nuevos colores azul y blackberry. Todos los colores están tan en sintonía que quedan muy bien con cualquier tono natural o de madera, así como con el blanco, el negro y el grafito. Los colores Selection son extremadamente versátiles y muy apreciados en la cocina.

### COLOUR SELECTION

Alla nostra gamma di colori Selection, cioè borgogna, eucalipto, oceano e terra d'ombra, si aggiungono ora le nuove tonalità azul e blackberry, fatte per dare un tocco di vivacità alle cucine moderne. Sono colori appositamente studiati per abbinarsi in modo ideale a tutte le sfumature naturali e del legno, al bianco come anche al nero e al grigio grafito. I colori della gamma Selection vanno davvero bene su tutto e particolarmente gradevoli in cucina.

### SELECTION FARVER

Vores selection farver er Burgundy, Eucalyptus, Ocean og Umbra-natur, der sammen med de nye farver Azur og Blackberry - bidrager med livlige accenter i moderne køkkener. Samtlige farvetoner er afstemt, så de passer optimalt sammen med alle natur- og træfarver og til hvid og sort samt grafit. Vores selection farver er ægte all-roundere, der tager sig perfekt ud i et køkken.



### EUCALYPTUS

EUCALIPTO  
EUCALIPTO  
EUKALYPTUS



### NATURAL UMBER

UMBRA NATURAL  
OMBRA NATURALE  
NATUR-UMBRA



### OCEAN

OCEAN  
OCEANO  
OCEAN



### BURGUNDY

BORGOÑA  
BORGOGNA  
BURGUND



### AZUR

AZUR  
AZUR  
AZUR



### BLACKBERRY

BLACKBERRY  
BLACKBERRY  
BLACKBERRY

# EUCALYPTUS

A colour that combines growth, nature, freshness and hope. Eucalyptus is like the harmonious middle, standing for calm and serenity. Green shades represent relaxation and bonhomie. Seen symbolically, colours like eucalyptus show a healthy detachment and thoughtful withdrawal.

## EUCALIPTO

*El color que une el crecimiento, la naturaleza, el frescor y la esperanza. El eucalipto es como un centro armonioso que representa la tranquilidad y la serenidad. Los tonos verdes evocan relajamiento y bondad. Desde un punto de vista simbólico, los colores como el eucalipto representan el distanciamiento sano y el recogimiento reflexivo.*

## EUCALIPTO

*Un colore che sintetizza crescita, natura, freschezza e speranza. Il colore eucalipto è il centro di equilibrio di tranquillità e rilassatezza. Le tonalità verdi suggeriscono calma e bonarietà. Nella forza simbolica, i colori come l'eucalipto ispirano un sano distanziamento e una sobrietà riflessiva.*

## EUKALYPTUS

*En farve, der forener vækst, natur, friskhed og håb. Eukalyptus er som et harmonisk midtpunkt og står for fred og ro i sindet. Grønne farvetoner repræsenterer afslapning og godmodighed. Symbolsk set viser farver som eukalyptus en sund distance og eftertænksom tilbagetrukkethed.*



**BRISTOL** Eucalyptus | Eucalipto | Eucalipto | Eukalyptus



**PORTO-GL** Eucalyptus | Eucalipto | Eucalipto | Eukalyptus

**PORTO-GL** Black | Negro | Nero | Sort



# NATURAL UMBER

Naturalness in its purest form. The earthy base shade natural umber provides a down-to-earth sensation, stability and security. Earth shades always have a calming and cosy effect. We symbolise natural umber with cosiness, gentleness and nature. A great shade that gives wood and black a radiance all of their own.

## UMBRA NATURLIG

Naturligt i dess renaste form. Den jordiga grundtonen umbra naturlig är jordnära och sprider en känsla av trygghet och stabilitet. Jordtoner har alltid en lugnande och behaglig verkan. Vi förknippar umbra naturlig med hemtrevnad, mildhet och natur. En fantastisk nyans som lyfter fram träet och det svarta på ett helt unikt sätt.

## OMBRA NATURALE

La naturalezza nella sua forma più pura. La tonalità terrosa dell'ombra naturale ispira praticità, stabilità e protezione. Le sfumature terrose creano sempre un effetto di calma e comfort. Per noi ombra naturale è sinonimo di accoglienza, delicatezza e natura. Una tonalità fantastica, che dona alle essenze legno e al nero un'esclusiva potenza di luminosità.

## NATUR-UMBRA

Rendyrket naturlighed. Den jordfarvede grundtone i umbra natur giver jobbundenhed, stabilitet og tryghed. Jordfarver virker altid beroligende og behagelige. Vi sætter umbra natur i forbindelse med hygge, blidhed og natur. En flot farvetone, som giver træ og farven sort et særligt design



**BRISTOL** Natural umber | Umbra naturlig | Terra d'ombra naturale | Natur-umbra



**PORTO-GL** Natural umber | Umbra naturlig | Terra d'ombra naturale | Natur-umbra

**PORTO-GL** Black | Svart | Nero | Sort



# OCEAN

Ocean, the symbol of reliability, sovereignty and strength. Dark blue shades radiate confidence and maturity. Ocean provides for inner contemplation but still provides foresight. Probably the most popular colour of all - it stands for balance and contentment, for truth, honesty and creativity. A real all-rounder.

## OCEAN

*Océano, el símbolo de la fiabilidad, la superioridad y la fuerza. Los tonos azul marino transmiten confianza y madurez. Océano proporciona introspección interior, pero también concede perspicacia. Seguramente, el color más popular de todos. Representa el equilibrio y la satisfacción, así como la verdad, la honestidad y la creatividad. Un auténtico multitalento.*

## OCEANO

*Oceano, l'immagine ideale di affidabilità, superiorità e forza. Il blu scuro ispira fiducia e maturità. Oceano invita al raccoglimento interiore e spinge comunque lo sguardo verso l'orizzonte. È il colore preferito iper eccellenza: ispira equilibrio e soddisfazione, verità, sincerità e creatività. Un vero talento di versatilità.*

## OCEAN

*Ocean, indbegrebet af tilforlidelighed, suverænitæt og kraft. Mørkeblå farvetoner udstråler tillid og modenhed. Ocean sørger for indre refleksion og giver alligevel overblik. Det er nok den populæreste farve overhovedet - den står for indre balance og tilfredshed, for sandhed, ærlighed og kreativitet. Et ægte multitalent.*



**HAMPTON-GL** Ocean | Océano | Oceano | Ocean

**PORTO** Crema-magnolia | Crema-magnolia | Crema-magnolia | Crème-magnolie



**PORTO-GL** Ocean | Océano | Oceano | Ocean

**PORTO-GL** Natural umber | Umbra natural | Terra d'ombra naturale | Natur-umbra



# BURGUNDY

Has a sumptuous effect on the eyes and soul. This shade radiates comfort, warmth and elegance. Burgundy also has a royal air, is representative and symbolises dominion and power. Rich dark red shades also represent luxurious indulgence and hint at sensuality.

## BOURGOGNE

En dyrgrip för ögon och själ. Färgnyansen utstrålar komfort, värme och elegans. Bourgogne har ett kungligt utseende, är representativt och symboliserar styre och makt. Rika, mörka röda färgtoner representerar också lyxig njutning och sprider en sensuell känsla.

## BORGOGNA

Prezioso per gli occhi e per lo spirito. Questo colore richiama un senso di comfort, calore ed eleganza. Il borgogna suggerisce anche maestosità, rappresentanza e simboleggia dominio e forza. La pienezza del rosso scuro evoca anche piacere lussuoso e suggerisce sensualità.

## BURGUND

Virker kostbar for øjne og sjæl. Denne farve udstråler velvære, varme og elegance. Burgund har også et royalt anstrøg, er repræsentativ og symboliserer status og styrke. Mættede mørkerøde farver står også for luksuriøs nydelse med en undertone af sanselighed.



**HAMPTON-GL** Burgundy | Bourgogne | Borgogna | Vinrød

**PORTO** Crema-magnolia | Crema-magnolia | Crema-magnolia | Crème-magnolie



**PORTO-GL** Burgundy | Bourgogne | Borgogna | Vinrød

**PORTO-GL** Natural umber | Umbra natural | Terra d'ombra naturale | Natur-umbra





# AZUR

A fantastic combination of blue and green - mystical and magical. A muted shade that stands out in the elemental play of the sky and clouds. A colour that clings to nature and is also reminiscent of deeper layers of water

## AZUR

*En fantastisk kombination av blått och grönt – mysigt och magiskt. En dämpad nyans som hör hemma bland molnens vilda lek över himlen. En färg som hör naturen till och som för tankarna till djupa vatten.*

## AZUR

*Una fantastica combinazione di blu e verde, misteriosa e magica. Una tonalità bilanciata per mettere in risalto il gioco primordiale tra cielo e nuvole. Un colore che appartiene alla natura e che richiama anche le profondità delle acque.*

## AZUR

*En fantastisk kombination af blå og grøn – hemmelighedsfuld og magisk. En dæmpet nuance, der udskiller sig markant i himlens og skyernes elementære spil. En farve, der fastholder naturen og også minder om de dybere vandlag.*



PORTO-GL Azur | Azur | Azur | Azur

PORTO-GL Black | Svart | Nero | Sort



# BLACKBERRY

Probably the fruitiest seduction in the world of colours. The blackberry shade is reminiscent of juicy, dark berries and looks particularly regal in combination with gold and bronze. Dark, rich and mysteriously shimmering, blackberry is the new black for aesthetes.

## BLACKBERRY

*Probablemente, la tentación más frutal de todo el mundo de los colores. El tono Blackberry evoca las bayas oscuras y jugosas, pero combinado con el oro y el bronce tiene un aspecto majestuoso. Los amantes de lo bello reconocen en el Blackberry oscuro, intenso y enigmáticamente brillante a su nuevo color negro.*

## BLACKBERRY

*La seduzione più fruttata nel mondo dei colori. La tonalità Blackberry ricorda la succosità delle bacche scure e in combinazione con l'oro ed il bronzo assume un aspetto decisamente regale. Scuro, intenso e misteriosamente luminoso, il blackberry diventa il nuovo nero per chi ama l'estetica.*

## BLACKBERRY

*Den nok mest frugtbare forfører i farvernes verden. Farven Blackberry minder om mørke, saftige bær og ser meget kongelig ud i kombination med guld og bronze. Blackberry er det nye sort for æstetikere - mørk, fyldig og med et mystisk skær.*



PORTO Blackberry | Blackberry | Blackberry | Blackberry



## SPECIAL DETAILS

Unlimited possibilities included. We plan, configure and implement customer requests. The personal aspiration decides - We offer the large selection. The details of the pull-out versions, doors and flaps, colours, fronts and shelves are real eye-catchers that never fail to excite.



### DETALLES ESPECIALES

Planificamos los deseos del cliente, los configuramos y los realizamos. La exigencia personal decide - nosotros ofrecemos la gran elección.

Con las variantes de extraíbles, puertas y abatibles, colores, frentes y estanterías son los detalles un punto de vista especial, que siempre entusiasma.

### DETTAGLI SPECIALI

Possibilità illimitate incluse: progettiamo intorno ai desideri del cliente, li configuriamo, li realizziamo. A decidere sono le esigenze personali, noi ci mettiamo l'ampia possibilità di scelta. Che siano le varianti dei cassetti, delle ante e degli sportelli, o i modelli, i colori e le finiture, i dettagli attirano sempre lo sguardo e sanno sempre entusiasmare.

### SÆRLIGE DETALJER

Ubegrænsede muligheder. Vi planlægger og konfigurerer kundernes ønsker og fører dem ud i livet. Den personlige smag er det afgørende - vi sørger for det store udvalg. Ved de forskellige udstrækstyper, døre og låger, farver, fronter og reoler er detaljerne særlige blikfang, som altid vækker begejstring.

## THE PERFECT HEIGHT FOR EVERYONE

For all kitchens - whether fronts with handles, knobs or for the handleless variant ART. All requirements for the perfect height of cupboards and worktops can be realised with our diverse body heights. Beautifully elegant: ART versions inspire with the clear lines of the same-height handleless rails.

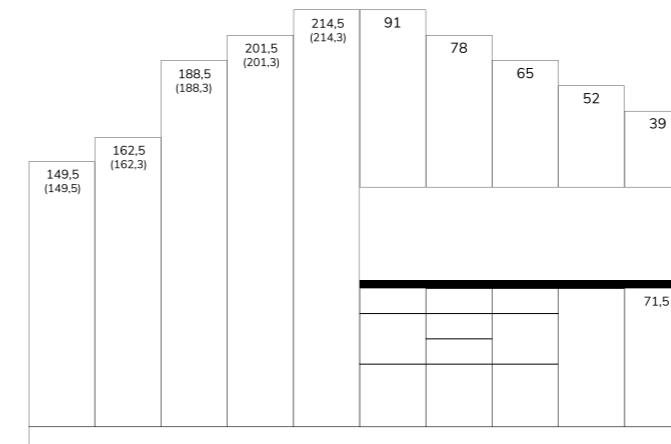

715 mm

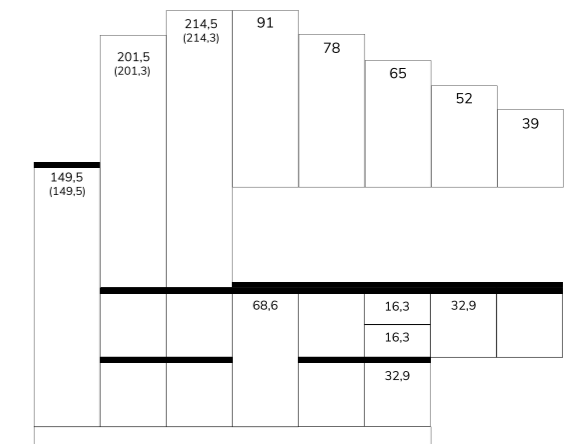

715 mm ART

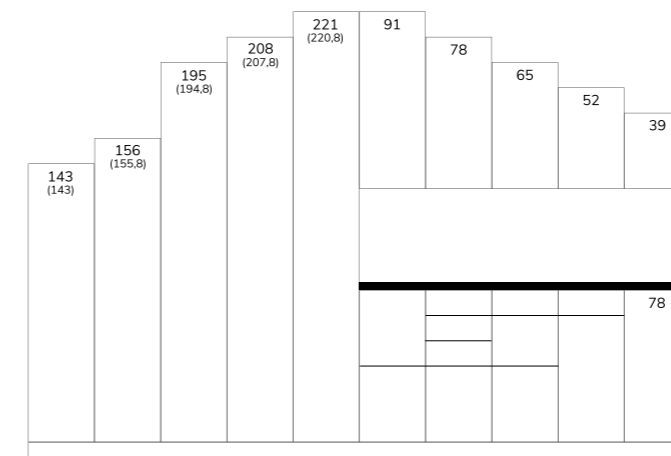

780 mm

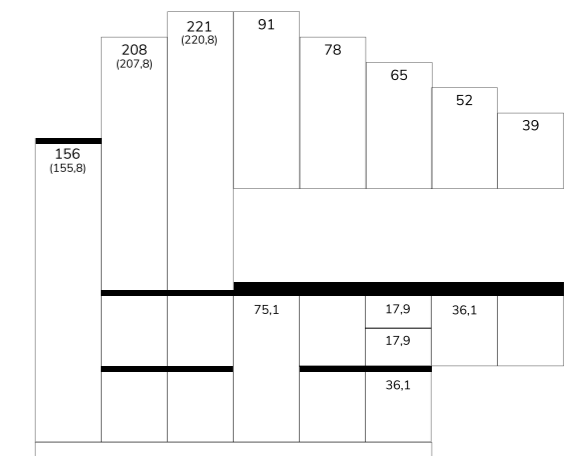

780 mm ART

### LA ALTURA PERFECTA PARA TODO EL MUNDO

Y para todas las cocinas. No importa si los frentes llevan tiradores o botones o si se prefiere la variante sin tiradores ART. Todos los requisitos para la altura perfecta de armarios y encimeras se pueden realizar con nuestra amplia gama de alturas de carcasa. De lo más elegante: las variantes ART seducen con las líneas bien definidas de los perfiles gola a la misma altura.

### L'ALTEZZA PERFETTA PER TUTTI

Per ogni cucina l'altezza giusta, che sia con le maniglie, i pomelli o nella variante ART con la gola. Con le varie altezze dei nostri elementi, è possibile soddisfare tutte le esigenze di avere l'altezza perfetta per basi e top. Bellezza raffinata: le varianti ART affascinano per le linee pulite e armoniose delle gole alla stessa altezza.

### DEN PERFEKTE HØJDE TIL ALLE

Til alle køkkener - uanset om det er fronter med greb, knopper eller den grebsløse variant ART. Alle krav til den perfekte højde på skabe og bordplader kan opfyldes med vores brede udvalg af højder. Smukt og ædelt: ART-versionerne inspirerer med de klare linjer i listerne, som er i samme højde.



## LIVING COLLECTION – VARIETY FOR LIVING SPACES

The Living Collection includes modern wardrobes, practical lowboard and high-quality sideboards in different versions. Strong design, durable materials and great variety ensure the perfect arrangements selection. All the furniture is made for open-plan living and provides individual freedom in the design of the living space.

### LIVING COLLECTION: DIVERSIDAD PARA LA ZONA LIVING

La colección Living incluye guardarpapas modernas y aparadores de alta calidad en múltiples variantes. Diseño potente, materiales duraderos y una gran variedad disponible garantizan que el conjunto elegido siempre esté perfecto. Todos los muebles parecen creados expresamente para entornos abiertos del living y proporcionan libertad individual en el diseño del espacio de vivir.

### LIVING COLLECTION: VARIETÀ PER LA ZONA LIVING

La nostra living collection offre moderni guardaroba, pregiate credenze e pratiche pareti soggiorno in numerose varianti. Design compatto, materiali durevoli e ampia scelta fanno in modo di ottenere sempre le migliori composizioni. Tutti i mobili sono studiati per ambienti open space e per personalizzare l'arredamento della zona living.

### LIVING COLLECTION VARIATION TIL OPHOLDSOMRÅDET

Living Collection omfatter moderne garderobeskabe, praktiske lowboards og skænke af høj kvalitet i forskellige udgaver. Stærkt design, holdbare materialer og stort udvalg sikrer, at de valgte kombinationer altid er perfekte. Alle møblerne er lavet til åben planløsning og giver individuel frihed i indretningen af boligen.



## 10 PRECONFIGURED WARDROBE VARIANTS

10 variantes preconfiguradas  
de guardarpapas

10 varianti di guardaroba  
preconfigurate

10 forudkonfigurerede  
garderober Varianter

## 10 PRECONFIGURED LOWBOARD VARIANTS

10 variantes preconfiguradas  
de aparadores

10 varianti di parete soggiorno  
preconfigurate

10 forudkonfigurerede  
lowboard Varianter

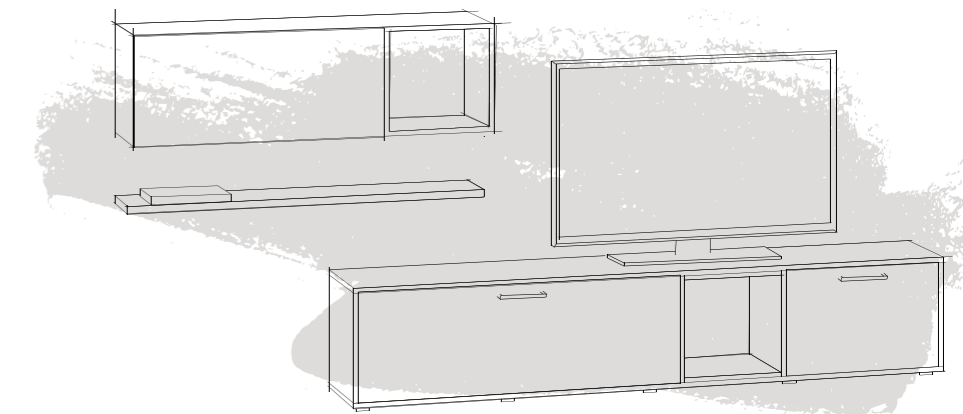

## 6 PRECONFIGURED SIDEBOARD VARIANTS

6 variantes preconfiguradas  
de aparadores

6 varianti di credenza preconfigurate

6 forudkonfigurerede  
Skænke Varianter

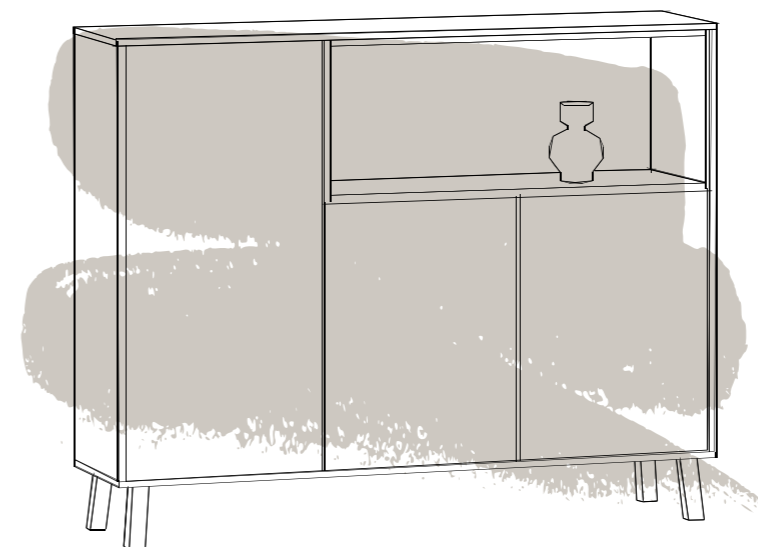

# WARDROBES – CONVINCING ALL-ROUNDERS

Ten pre-configured wardrobe variants offer additional storage space in the corridor and hallway. Store your coat, gloves, scarves, hats or other things in style. Wardrobes impress with minimalist design, the best workmanship and the greatest possible colour range to match the kitchen front on request.

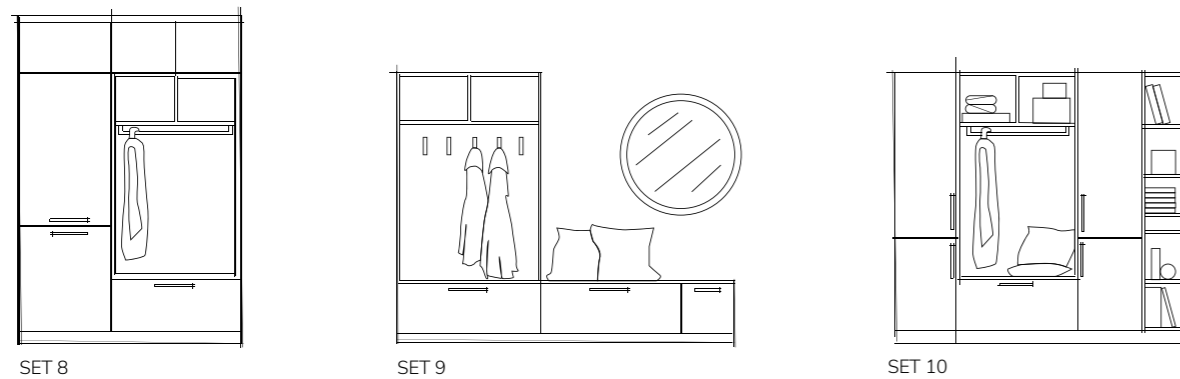
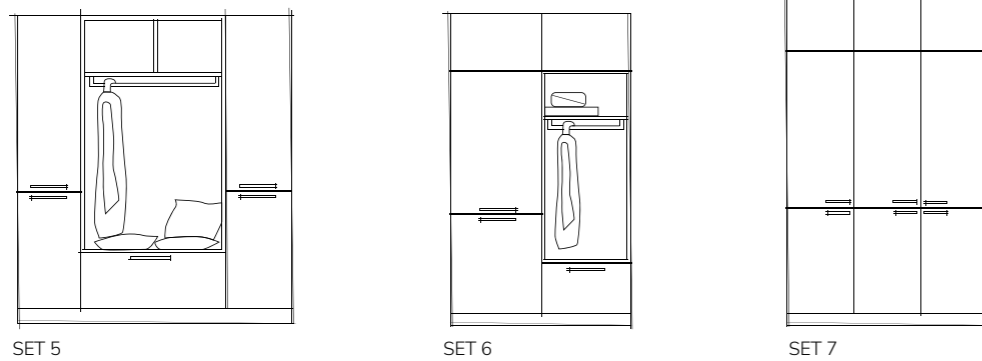
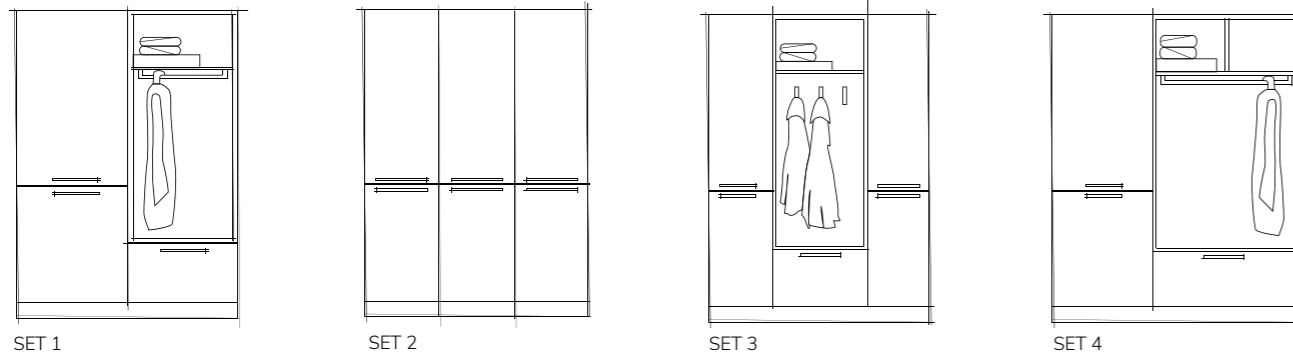

## GUARDARROPAS: LOS MULTITALENTOS INDISCUTIBLES

Las diez variantes preconfiguradas de guardarropas proporcionan más espacio de almacenamiento en el pasillo o el vestíbulo. Aquí quedan a buen recaudo y con mucho estilo los abrigos, los guantes, las bufandas, los gorros o incluso otros enseres. Los guardarropas impresionan por su diseño minimalista, el acabado impecable y por presentar la gama más grande de colores posible. Si lo desea, pueden ir a juego con los frentes de la cocina.

## GUARDAROBA: TUTTOFARE CHE SANNO IL FATTO LORO

Dieci varianti preconfigurate di guardaroba offrono tanto spazio in corridoio e in ingresso per cappotti, guanti, sciarpe, berretti e altri indumenti. Il design minimalista dei guardaroba affascina, come anche la qualità della lavorazione e l'ampia scelta di colori, abbinabile su richiesta alle ante della cucina.

## GARDEROBESKABE - OVERBEVISENDE ALLROUNDERE

Ti forudkonfigurerede varianter af garderobeskabe giver ekstra opbevaringsplads i entréen og gangen. Her kan du opbevare din frakke og lignende, handsker, tørklæder, huer eller andre ting med stil. Klædeskabene imponerer med minimalistisk design, det bedste håndværk og det størst mulige udvalg af farver – som på forespørgsel kan matches med køkkenfronten.



# LOWBOARDS – STRAIGHT-LINE MEDIA FURNITURE

Exclusively designed for carefree television enjoyment. The ten preconfigured lowboards variants have been designed with a minimal visual presence to guarantee a clear view of the screen. Cables, connections and adapters can be completely concealed behind the rear panels. For all those for whom „less is more“ is not just a statement.

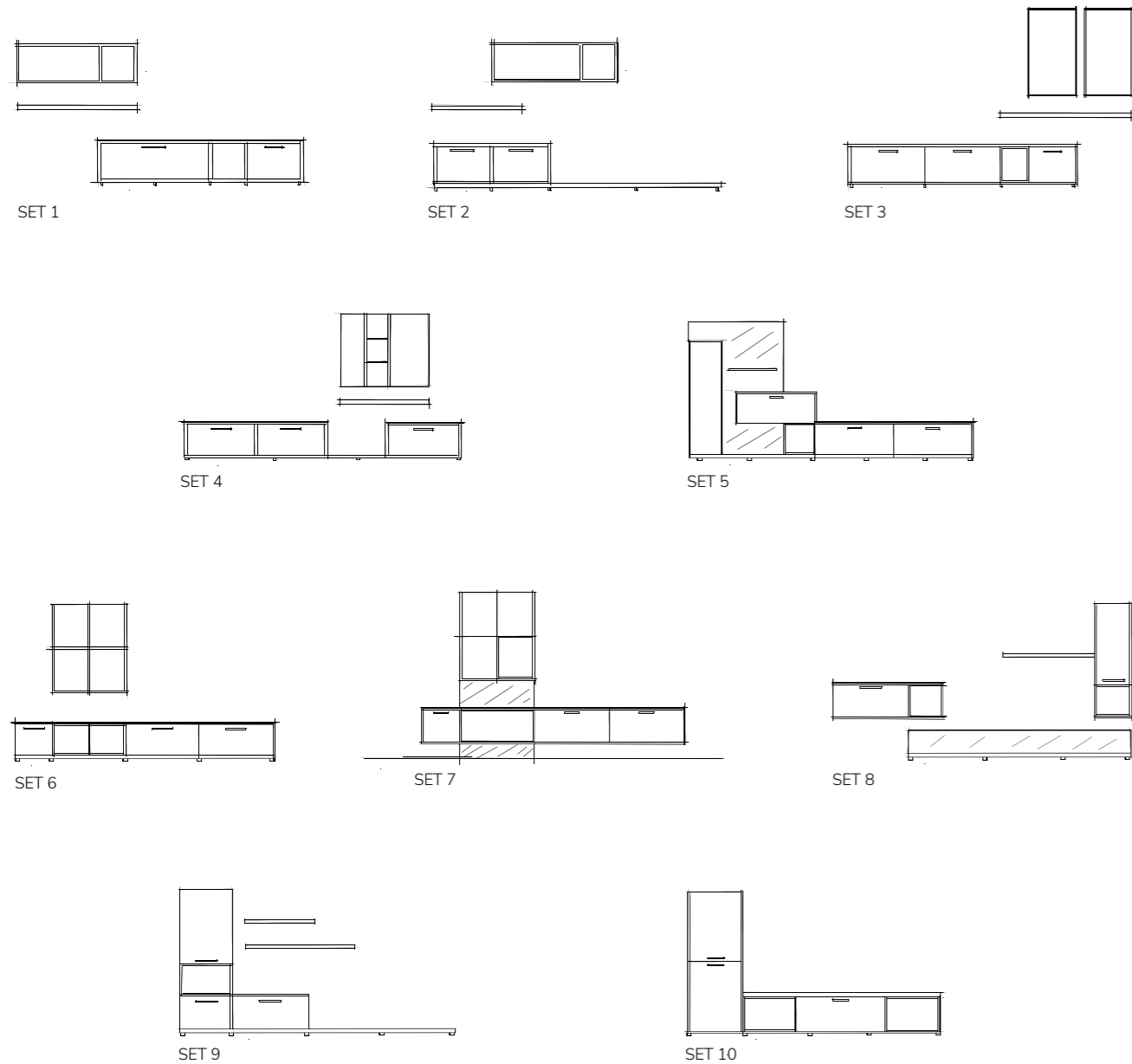

## APARADORES: LOS MUEBLES DE LÍNEAS RECTAS PARA EL ENTRETENIMIENTO

Hechos a posta para disfrutar sin límites de la televisión. Las diez variantes preconfiguradas de aparadores se mantienen visual y deliberadamente compactas para que nada obstaculice la visión de la pantalla. Los cables, los enchufes y los adaptadores quedan ocultos detrás de la trasera. Para quienes el «menos es más» significa algo más que unas simples palabras bonitas.

## LOWBOARD – MOBILI PER MEDIA DALLE LINEE DIRITTE

Creata appositamente per godersi la televisione senza pensieri. Le dieci varianti preconfigurate di lowboard sono studiate in una voluta sobrietà e assicurano una libera visione dello schermo. Cavi, collegamenti e adattatori si nascondono invisibili dietro gli schienali. Per chi non ritiene che „meno è più“ sia soltanto una frase fatta.

## SKÆNKE – FUNKTIONELLE ENKELTMØBLER

De kan holde til meget. Markante strukturer sammensat med visuel lethed – de seks forud konfigurerede skænkevarianter har alle ideel opbevaringsplads og præsenterer dine dekorative genstande fra deres bedste side. Moderne ledsagere til enhver bolig i enkle design, der kan integreres i ethvert boligmiljø for at spare plads.



## SIDEBOARDS – FUNCTIONAL STANDALONE FURNITURE

As sturdy as they come. Clear structures paired with visual lightness – the six pre-configured sideboard variants offer ideal storage space and let special decorative items truly shine. Modern living companions in simple designs that can be integrated into any living environment to save space.

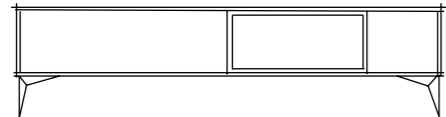

SET 1

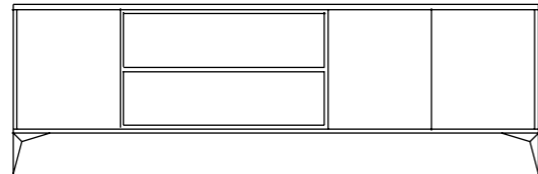

SET 2

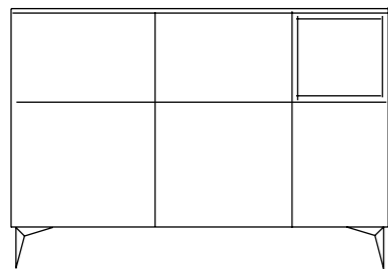

SET 3

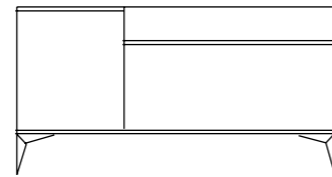

SET 4

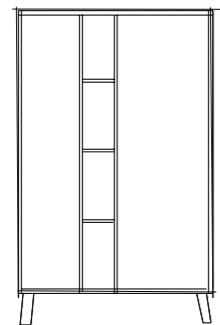

SET 5

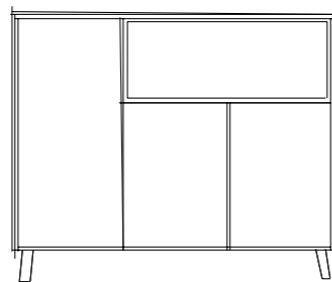

SET 6



### APARADORES: LOS MUEBLES FUNCIONALES POR SÍ SOLOS

Para guardarlo todo bien ordenado. Las estructuras nítidas se unen a ligereza visual: las seis variantes preconfiguradas de aparadores ofrecen la capacidad de almacenaje ideal y muestran lo mejor de los objetos decorativos especiales. Son los acompañantes modernos con diseños sencillos y se integran en cualquier entorno doméstico sin apenas ocupar espacio.

### CREDENZE: ELEMENTI SOLITARI FUNZIONALI

Mobili che sanno il fatto loro. Strutture semplici dall'estetica leggera: le sei varianti preconfigurate di credenze offrono grande capienza e mettono in evidenza al meglio gli oggetti decorativi speciali. Compagni di casa moderni dal design semplice, perfettamente inseribili in ogni tipo di abitazione con il minimo di ingombro.

### SKÆNKE – FUNKTIONELLE ENKELTMØBLER

De kan holde til meget. Markante strukturer parret med visuel lethed – de seks forudkonfigurerede skænkevarianter har alle ideel opbevaringsplads og præsenterer dine dekorative genstande fra deres bedste side. Moderne ledsagere til enhver bolig i enkle design, der kan integreres i ethvert boligmiljø for at spare plads.

## STRONG BASE CARCASE

Eleven harmonious colours form the fresh basis for kitchen cabinets and the like. To make kitchens as individual as possible, we also offer eight different glossy visible sides to complement these carcass colours. Important freshness boost: the interior colour of the corpus is always crystal white. An all-round success.



### BASE SÓLIDA ARMAZÓN

Once armoniosos colores forman la flamante base para armarios de cocina y acompañantes. Ofrecemos otras ocho costados visibles en brillo para complementar estos colores y conseguir que la cocina sea lo más personalizada posible. Una nota importante que realza la frescura: el interior del armazón siempre es blanco cristal. Un resultado redondo.

### ROBUSTA STRUTTURA DELLA SCOCCA

Undici colori coordinati sono una base ricca di tanta freschezza per i mobili della cucina. Per rendere la cucina il più personalizzata possibile sono inoltre disponibili, esclusivamente per i lati a vista, ben otto diversi colori in finitura lucida. Un altro importante tocco di freschezza: il colore interno delle scocche è sempre il bianco cristallo. Un successo a 360 gradi.

### STÆRKE BASIS KORPUS

For at kunne fremstille køkkener så individuelt som muligt, tilbyder vi som supplement til disse elleve korpusfarver yderligere otte forskellige blanke skabsider. Et vigtigt frisk pust: Den indvendige korpusfarve er altid krystalhvid. Vellykket hele vejen igennem.

THE INTERIOR COLOUR OF THE CARCASE IS ALWAYS CRYSTAL WHITE.

El interior del armazón siempre es blanco cristal.  
Il colore interno degli elementi è sempre il bianco cristallo.  
Den indvendige farve i korpus er altid krystalhvid.

## STANDARD CARCASES

### ARMAZONES ESTANDÁR SCOCHE STANDARD STANDARDKORPUS – OVERSIGT



4077 Crystal white  
4077 Blanco cristalino  
4077 Bianco cristallo  
4077 Krystal Hvid

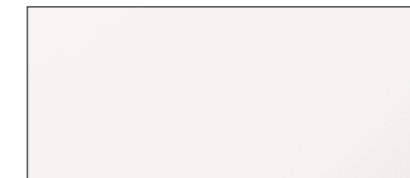

4052 Polar white  
4052 Blanco polar  
4052 Bianco polare  
4052 Polarhvid

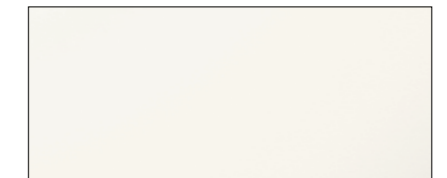

4038 White  
4038 Blanco  
4038 Bianco  
4038 Hvid

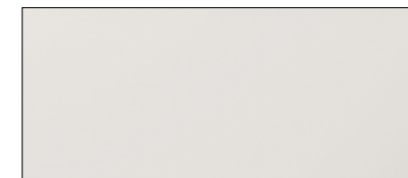

4176 Taupe  
4176 Satén  
4176 Satin  
4176 Satin

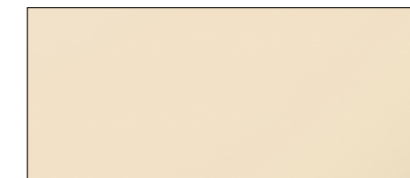

4219 Crema-magnolia  
4219 Crema-magnolia  
4129 Crema-magnolia  
4129 Crema-magnolia

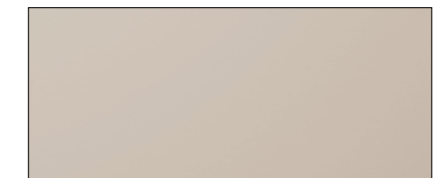

4340 Cashmere  
4340 Cachemir  
4340 Cachemire  
4340 Kasmir

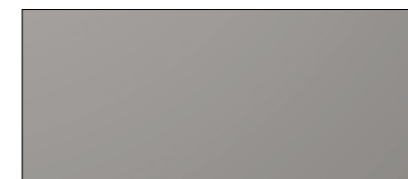

4078 Pearl grey  
4078 Gris perla  
4078 Grigio perla  
4078 Perlegrå



4376 Graphite  
4376 Grafito  
4376 Grafite  
4376 Grafit



4224 Black  
4224 Negro  
4224 Nero  
4224 Sort



4233 Natural vintage oak  
4233 Roble envejecido natural  
4233 Rovere antico natura  
4233 Natural Vintage Eg

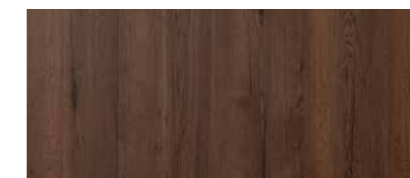

4228 Cognac vintage oak  
4228 Roble envejecido coñac  
4228 Rovere antico cognac  
4228 Cognac Vintage Eg



# HANDLELESS

At handleless, the carcass sides are already prepared for installation and are available in different colour versions. At the end of the line, it is possible to plan with gable end in front shape.

## SIN TIRADOR

Para las cocinas con golas los laterales del armazón están fresados listos para la instalación y están disponibles en diferentes colores. Al final de la fila es posible planificar con costados de frentes.

## GOLA

Nella linea gola i fianchi della scocca vengono fresati e predisposti direttamente in fabbrica pronti per il montaggio e sono disponibili in diversi colori e finiture. È inoltre possibile inserire i fianchi laterali con la gola riportata, esattamente come le ante.

## GREBLØS

Med grebløs fræses korpussiderne klar til montering og fås i forskellige farvevarianter. I slutningen af linjen kan der planlægges med frontafslutning.



**377 Crystal white matt**  
377 Blaco cristallino mate  
377 Bianco cristallo opaco  
377 Krystal Hvid mat



**352 Polar white matt**  
352 Blanco polar mate  
352 Bianco polare opaco  
352 Polarhvid mat



**305 White matt**  
305 Blanco mate  
305 Bianco opaco  
305 Hvid mat



**319 Crema-magnolia matt**  
319 Crema-magnolia mate  
319 Crema-magnolia opaco  
319 Crema-magnolia mat



**363 Taupe matt**  
363 Satén mate  
363 Satin opaco  
363 Satin mat



**340 Cashmere matt**  
340 Cachemir mate  
340 Cachemire opaco  
340 Kasmir mat



**378 Pearl grey matt**  
378 Gris perla mate  
378 Grigio perla opaco  
378 Perlegrå mat



**376 Graphite matt**  
376 Grafito mate  
376 Grafite opaco  
376 Grafit mat



**355 Black matt**  
355 Negro mate  
355 Nero opaco  
355 Sort mat



**320 Stainless steel coloured brushed**  
320 Colores acero inoxidable  
320 Color acciaio inox.  
320 Rustfritstål farvet



**364 Gold col. brushed**  
364 Dorado cepillado  
364 Colore oro spazzolato  
364 Børstede guldfarver



**323 Bronze col. brushed**  
323 Broce cepillado  
323 Effetto bronzo spazzolato  
323 Børste bronsefarve

## SELECTION FINISHES

SELECTION ACABADOS  
SELECTION ESECUZIONI  
SELECTION UDFØRELSE



**321 Eucalyptus matt**  
321 Eucalipto mate  
321 Eucalipto opaco  
321 Eukalyptus mat



**306 Natural umber matt**  
306 Umbra natural mate  
306 Terra d'ombra naturale opaco  
306 Natur-umbra mat



**388 Burgundy matt**  
388 Borgoña mate  
388 Borgogna opaco  
388 Vinrød mat



**372 Ocean matt**  
372 Océano mate  
372 Oceano opaco  
372 Ocean mat



**346 Blackberry matt**  
346 Blackberry mate  
346 Blackberry opaco  
346 Blackberry mat



**344 Azur matt**  
344 Azur mate  
344 Azur opaco  
344 Azur mat

## PULL-OUTS

The ideal programme for every kitchen: whisper-quiet and effortlessly sliding pull-outs. For even more storage space and safety with functional raised side frames. The best of design and function in your new kitchen. It makes keeping things tidy a real breeze.



### MÓDULOS EXTRAÍBLES

Los módulos extraíbles silenciosos y que se deslizan sin esfuerzo figuran en la lista de deseos de cualquier cocina. Proporcionan más espacio de almacenaje y seguridad con las alturas funcionales de los bastidores laterales. Este diseño funcional y digno de Best of Design busca sitio en su nueva cocina. Para que mantener las cosas ordenadas sea pan comido.

### CASSETTI E CESTONI

Un desiderio in ogni cucina: cassetti silenziosi e scorrevoli senza sforzo. Più posto e più sicurezza grazie ai miglioramenti funzionali delle sponde laterali. Il meglio del design e della funzionalità per la nuova cucina. Tenere in ordine diventa un gioco da ragazzi.

### UDTRÆK

Ønskeprogrammet til ethvert køkken: Lydløse og letbevægelige udtræk. For endnu mere opbevaringsplads og sikkerhed med funktionelt forhøjede sidesarge. „A Best of Design & Function“ i dit nye køkken. Så er det ingen sag at holde orden.

### METRO PULL-OUT WITH RAILING

Módulos extraíbles METRO con barandilla

Cestone METRO con ringhierina

Udtræks METRO med ræling



### METRO PULL-OUT WITH BOX

Módulos extraíbles METRO con caja

Cestone METRO con sponde box

Udtræks METRO med boks



### METRO PULL-OUT WITH GLASS

Módulos extraíbles METRO con cristal transparente

Cestone METRO con sponde in vetro trasparente

Udtræks METRO med klart glas



## METRO PULL-OUT SYSTEMS

Cool idea: three different pull-out systems with a sophisticated platinum finish. The variant with railing is fitted as standard. For an additional charge, the side frames are also available as a box or fitted with clear glass. Practical, safe and beautiful - real heroes for better handling in the pull-out.

### SISTEMAS DE MÓDULOS EXTRAÍBLES METRO

¡Qué buena idea! Tres sistemas distintos para módulos extraíbles con una superficie acabada en un platino muy distinguido. La variante con barandilla viene montada de serie. Los laterales de los cajones también están disponibles como box o con cristal transparente. Prácticos, seguros y bonitos. Los verdaderos héroes que facilitan el manejo de los módulos extraíbles.

### SISTEMI DI CASSETTI METRO

Idea brillante: tre diversi sistemi di cassetti con raffinata finitura superficiale color platino. Di serie è prodotta la variante con listello. Con maggiorazione di prezzo, il telaio laterale è disponibile anche come box o dotato di vetro trasparente. Pratico, sicuro e bello: un supereroe per una gestione migliore del cassetto.

### UDTRÆKSSYSTEMERNE METRO

Cool ide: Tre forskellige udtrækssystemer med en elegant overfladefinish i platin. Som standard monteret med udgaven med ræling. Mod en merpris leveres sidesargene også som boks eller monteret med klart glas. Praktisk, sikkert og smukt - de sande helte for bedre håndtering af udtrækket.

## CLIMBER – BLACK EDITION

Opens and closes by sensor switch. This fascinating wall cabinet features an electric glass slat front, two shelves made of Parsol glass and a uniform black-in-black look. The translucent slats stack horizontally and raise silently. Slats are available in black tinted and black matt tinted glass.



### CLIMBER – BLACK EDITION

Apertura y cierre por interruptor de sensor. Este armario empotrado con frente eléctrico de láminas de cristal y dos estantes interiores de cristal parsol también seduce con su look uniforme de negro sobre negro. Las láminas traslúcidas suben horizontalmente sin hacer ruido. Las láminas están disponibles tintadas en negro y en negro mate.

### CLIMBER – BLACK EDITION

Si apre e si chiude con un sensore elettronico. Questo elemento a parete con serrandina e ripiani intarsiati in vetro Parsol affascina anche per la sua estetica total black. Le lamelle in vetro traslucido o opaco si spostano in alto silenziosamente in orizzontale. Il vetro nero è disponibile nella versione sia lucida che opaca.

### CLIMBER – BLACK EDITION

Åbnes og lukkes med sensorkontakt. Dette vægskab med elektrisk glaslamelfront og to hylde af parsolglas fascinerer også med sit ensartede look Black-in-Black. De gennemsigtige lameller kan justeres horisontalt og hæves lydløst, og fås i sorttonet og mat sorttonet.



## KUBUS METAL SHELF – MODULAR DECOR ITEM

The Kubus shelf with black metal frame captivates with its timeless design and a back panel interior tailored to your colour preference. A contemporary, modular decor item that enables a flowing transition from the kitchen to the living area and allows for endless combinations.

### ESTANTERÍA METÁLICA KUBUS:: EL ELEMENTO MODULAR PARA EL HOGAR

El estante KUBUS con marco metálico negro convence por su diseño atemporal y porque permite poner cualquier tono favorito en la pared trasera. Un mueble modular y al día para el hogar que hace posible una transición fluida entre la cocina y el salón y que, además, permite numerosas combinaciones.

### CUBOTTO IN METALLO: ELEMENTO D'ARREDO MODULARE

Il cubotto con telaio in metallo nero salta all'occhio per il suo design senza tempo e la possibilità personalizzare lo schienale con la finitura preferita. Un modulo d'arredo contemporaneo che accompagna nel passaggio dalla cucina alla zona living in tantissime combinazioni.

### METALHYLDEN KUBUS – MODULOPBYGGET HYLDE

Kubus-hylden med sort metalramme imponerer med sit tidløse design og muligheden for at montere bagpanelet i enhver ønsket farve på indersiden. Et moderne, modulopbygget boligobjekt, der sikrer en flydende overgang fra køkken til stue, og som kan kombineres på utallige måder.



## ILLUMINATED CHANNEL HANDLE – L-PROFILE AND C-PROFILE

It's the atmosphere that matters. In addition to the LED lighting of the L-profile under the worktop, it is also possible to equip the lower channel handle - the C-profile - with modern LED strip lighting. Light temperature can be individually adjusted from neutral white to warm white to cool white. Diverse lighting scenarios are thus possible.

### PERFIL GOLA ILUMINADO: LOS PERFILES L Y C

*Todo depende del ambiente. Aparte de la iluminación LED del perfil L bajo la encimera, también es posible equipar el perfil gola inferior (el perfil C) con una moderna tira de luz LED. La temperatura de la luz puede ajustarse de manera individual desde el blanco neutro pasando por el blanco cálido hasta llegar al blanco frío. Admite diversos escenarios de iluminación.*

### GOLA LUMINOSA: PER PROFILI A „L“ E „C“

*È l'atmosfera che fa la differenza. Oltre all'illuminazione con LED del profilo gola a L sotto il top, ora è possibile illuminare anche la gola inferiore con profilo a C. La temperatura della luce si regola passando dal bianco neutro al bianco caldo o al bianco freddo, rendendo possibili differenti scenari di illuminazione.*

### OPLYSTE KANTLISTER – L- OG C-PROFIL

*Det er atmosfæren, der tæller. Ud over LED-belysningen i L-profilen under bordpladen er det også muligt at udstyre den nederste liste – C-profilen – med moderne LED-stribelysning. Lystemperaturen kan justeres individuelt, fra neutral hvid til varm hvid til kold hvid. Dermed er forskellige lysscenarier mulige.*

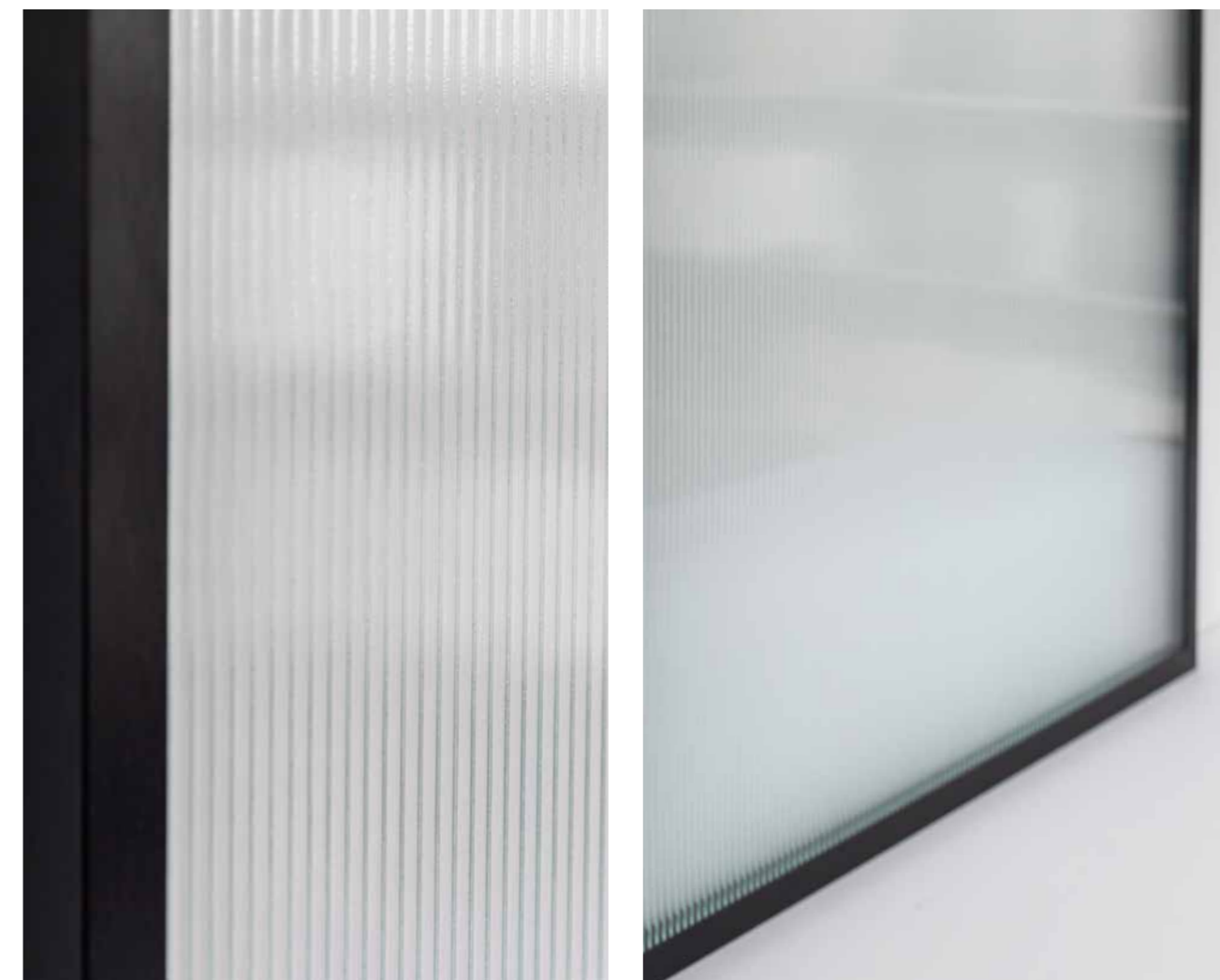

## METAL FRAME DOOR WITH GROOVED GLASS

Trendy industrial style. The black metal frame door is also available with a narrow, black metal frame. Both versions feature an elegant grooved glass, whereby the groove structure is directed outwards. Further to the striking look, there is a special haptic effect when you run your fingers over it.

### PUERTA CON MARCO METÁLICO Y CRISTAL RANURADO

*El estilo industrial que marca tendencia. La puerta con marco metálico en negro también está disponible con un marco metálico negro y estrecho. Las dos variantes incorporan un precioso cristal ranurado con la estructura de los surcos mirando hacia fuera. Aparte de tener un aspecto único, el efecto táctil que se crea al pasar los dedos por encima es muy especial.*

### ANTA DEL TELAIO METALLICO CON VETRO A RIGHE

*Stile industriale moderno. L'anta del telaio metallico in nero è disponibile anche con una sottile cornice metallica nera. Entrambe le varianti sono dotate di raffinato vetro a righe, la cui struttura è rivolta verso l'esterno. Oltre all'aspetto particolare, passandoci sopra con le dita si verifica uno speciale effetto tattile.*

### LÅGE MED METALRAMME OG RILLET GLAS

*Trendy industristil. Metalrammedøren i sort fås også med en smal, sort metalramme. Begge versioner er udstyret med fornemt rillet glas, hvor rillestrukturen vender udad. Ud over det specielle udseende giver dette en særlig fornemmelse, når man stryger fingrene hen over lågen.*



Cutlery tray solid wood light beech

Cubertero madera maciza

Portaposate legno massello

Bestikindsats massiv bøg

## INTERIOR ORGANISATION SYSTEM

Whether base units with solid wood inside organisation system and cutlery trays or integrated, additional drawers – innovative storage space concepts simplify your work and alleviate organisation.



Cutlery tray solid wood dark ashgrey

Fresno gris oscuro

Frassino grigio scuro

Ask mørkegrå

### ORGANIZACIÓN INTERIOR

Ya sean las gavetas de madera maciza con organización interior, o los portacubiertos, o los cajones adicionales integrados. Los innovadores conceptos de espacio de almacenaje facilitan el trabajo y consiguen el orden.

### L'ORGANIZZAZIONE DEGLI INTERNI

Che si tratti di inserti in legno massello con portaposate o di cassetti interni supplementari, gli evoluti sistemi di organizzazione degli spazi interni semplifica la vita e aiuta a mantenere l'ordine in cucina.

### INDRETNING

Uanset om fuldudtræk er med indretning af massivt træ og bestikindsatse eller integrerede ekstra sokkelskuffer – innovative opbevaringskoncepter gør arbejdet nemmere og skaber hurtigt orden og overblik.

## INTERIOR ORGANISATION SYSTEM MOVE

The internal organisation system MOVE, which is made of real wood, offers a lot of options to use the cabinet even smarter. Boxes in many sizes, cutlery trays, foil dispensers, knife holders and much more are making this concept very need. The anti-slip mats are helping to keep everything in it's spot.



### ORGANIZACIÓN INTERIOR MOVE

*Tanto los cajones de extensión total con organización interior de madera maciza y cuberteros como los cajones adicionalmente integrados son conceptos de almacenaje innovadores que facilitan el trabajo y logran el orden rápida y sencillamente.*

### SISTEMA DI ORGANIZZAZIONE INTERNO MOVE

*Che i cassetti siano dotati di organizzatori in legno massello o di inserti per posate e contenitori supplementari integrati, gli innovativi sistemi per l'organizzazione degli interni facilitano il lavoro ed aiutano a mettere tutto in ordine in modo facile e veloce.*

### SKUFFEINDRETNING MOVE

*Skuffeindretningsystemet MOVE af massivt træ giver mange anvendelsesmuligheder takket være de variable elementer – fire rum i tre højder og to forskellige grundflader. Bestikindsats, folieafroller, knivholdere og udligningselementer runder konceptet af, og en antiskridmåtte sørger for, at tingene bliver liggende på deres plads.*



## BEAUTIFUL LIGHT SOURCES – ENERGY-EFFICIENT AND SMART HOME COMPATIBLE



The minimalist pendant luminaire with LED light is visually unobtrusive, but provides the table surface with an excellent lighting ambiance.

### FUENTES DE LUZ PRECIOSAS, ENERGÉTICAMENTE EFICIENTES Y APTAS PARA EL HOGAR INTELIGENTE

A pesar de su aspecto discreto, la luminaria suspendida, minimalista y con luz LED crea una iluminación y un ambiente magníficos en la zona de la mesa.

### SPLENDIDA ILLUMINAZIONE: EFFICIENZA ENERGETICA PER LA CASA SMART

La lampada sospesa in stile minimalista con luce LED ha un'estetica sobria ma sa creare condizioni di luce ottimali su tutta la superficie del tavolo.

### SMUKKE LYSKILDER – ENERGIBESPARENDE OG SMART HOME-KOMPATIBLE

Den minimalistiske pendel-lampe med LED fremtræder optisk diskret, men skaber en fremragende lysatmosfære over bordfladen.

LED glass shelf and LED recessed spots in cupboard bottoms are also smart home compatible and provide perfect illumination of small areas in the living and dining area.

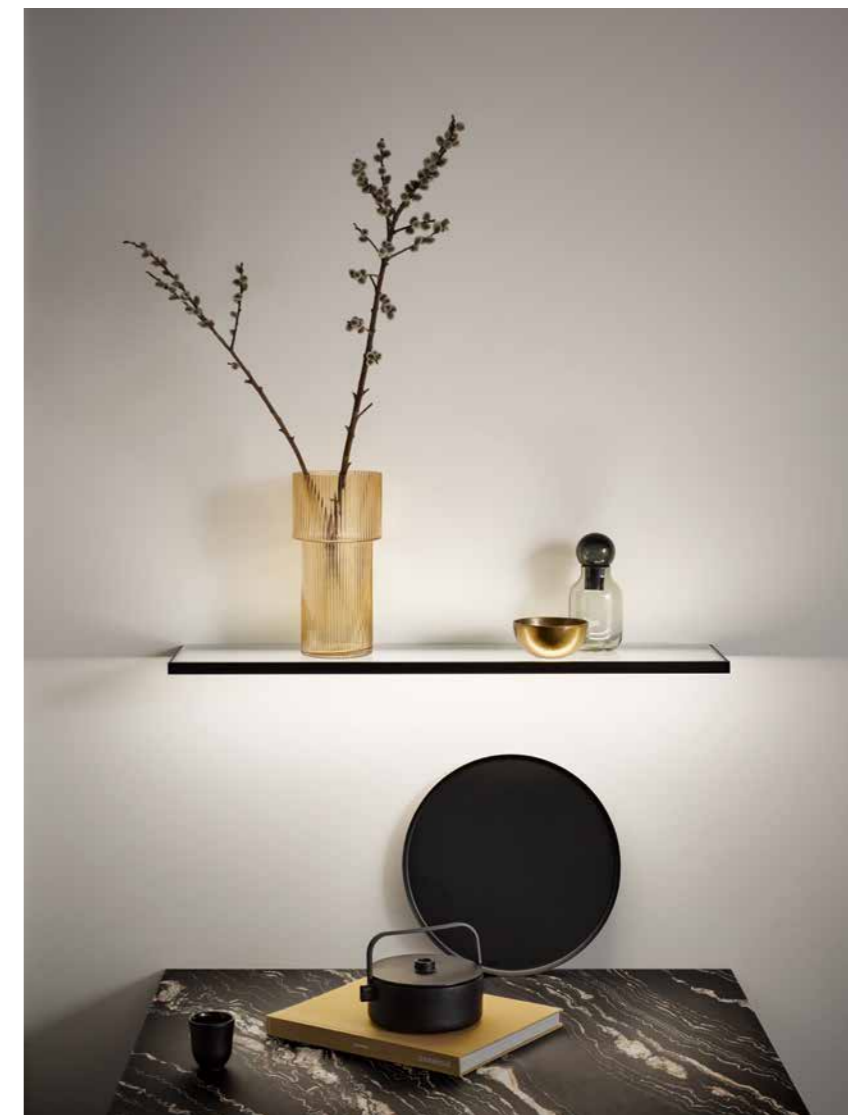

Los estantes de cristal con LED y los focos LED empotrados en la base de los armarios también se adaptan a los hogares inteligentes y crean la iluminación perfecta en las pequeñas superficies del salón y del comedor.

Anche i ripiani in vetro luminosi con LED e i faretti a LED a incasso nei fondi dei pensili sono compatibili con la tecnologia domotica e assicurano un'illuminazione perfetta di piccole superfici nella zona living e pranzo.

LED-glashylder og indbyggede LED-spots i skabshylder er også smart home-kompatible og giver en perfekt belysning på de små flader i opholdsstuen og i spise-stuen.

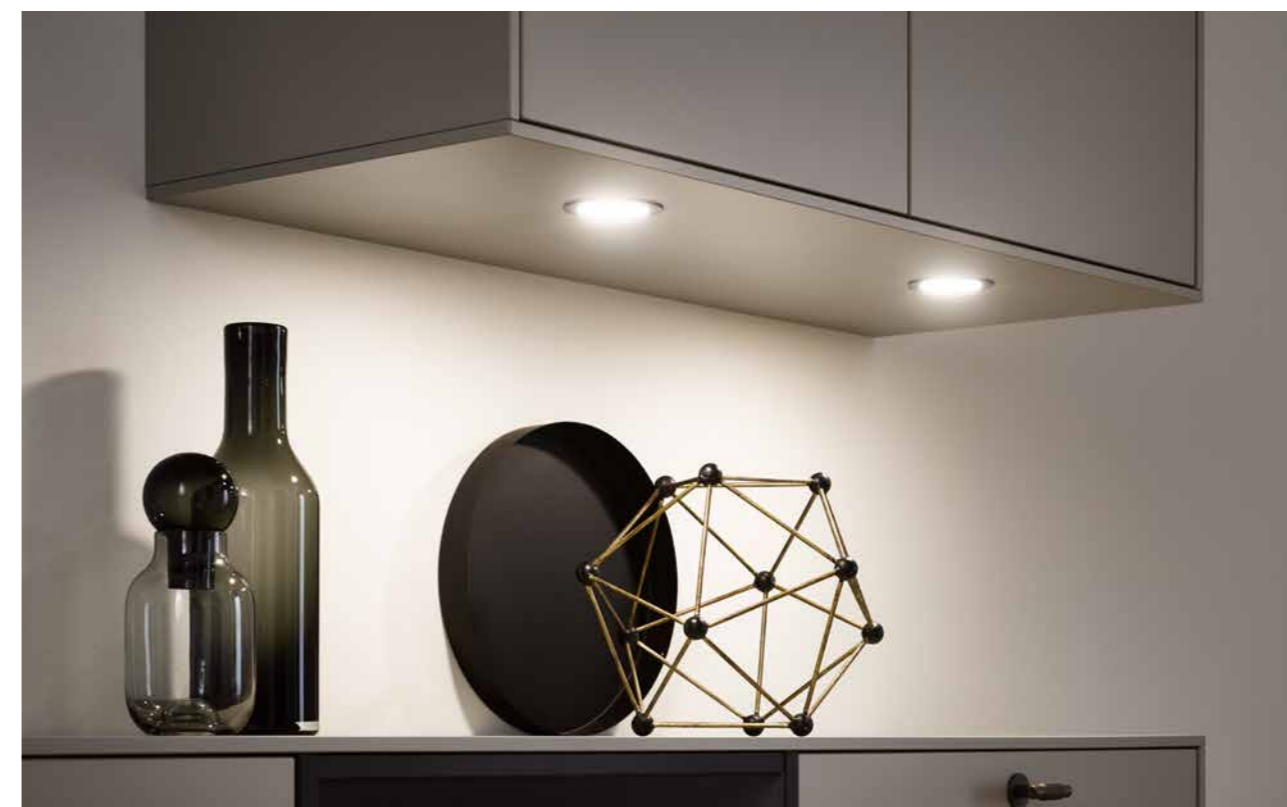



## RECESS EQUIPMENT LINERO EASYLINE

Put your things on display! The shelf from the Linero EasyLine series brings diversity to your kitchen nook and gives it an individual touch. Wooden module boxes from MOVE are decorative and sophisticated shelf accents. Spices, aromatic herbs and other utensils are from now ready to hand and mobile.



Nothing can surpass an illuminated recess railing that not only offers optimal lighting, but also an appealing ambience.

*Instalar un riel con iluminación en un nicho resulta muy práctico para trabajar en la cocina. Los sistemas de iluminación para conseguir la luz adecuada son numerosos y variados.*

*Un listello luminoso è davvero pratico per lavorare in cucina. Per un'illuminazione ottimale sono disponibili molti sistemi diversi.*

*Den belyste niche-ræling er meget praktisk ved køkkenarbejdet. Der findes mange forskellige lyssystemer til valg af optimal belysning.*

### EQUIPAMIENTO PARA NICHOS LINERO EASYLINE

*¿Paredes vacías? Sus objetos se merecen un puesto de honor. Las soluciones de almacenaje de la serie Linero EasyLine rompen con la monotonía de los nichos de cocina y dan un toque personal. Las cajas modulares de madera MOVE son elementos decorativos e ingeniosos para guardar las cosas. Ya puede tener las especias, las hierbas aromáticas o demás utensilios al alcance de la mano y moverlos de sitio cómodamente.*

### ACCESSORIO PER NICCHIA LINERO EASYLINE

*Pareti vuote? Ogni cosa ora ha il suo posto d'onore! I portaoggetti della serie Linero EasyLine movimentano la nicchia della cucina, donandole una nota personalizzata. I box modulari in legno MOVE aggiungono all'arredamento un tocco decorativo e intelligente. Spezie, intense erbe aromatiche o altri utensili sono sempre a portata di mano.*

### UDSTYR TIL KØKKENNICHEN LINERO EASYLINE

*Tomme vægge? – giv tingene en æresplads! Hylde fra serien Linero EasyLine skaber afveksling i køkkennichen og giver et individuelt præg. Træmodulboksene MOVE sørger for dekorative og gennemtænkte detaljer på hylde. Krydderier, herligt duftende urter eller andet tilbehør er transportable og altid indenfor rækkevidde.*





## SUSTAINABILITY

Sustainable production and lifestyles are the main topic of our time and ever-present. We rise to this challenge and work every day to bring all of what we do even more closely into harmony with environmental and social concerns. So, we live sustainability: For us, holistic corporate responsibility, the environment and society are inextricably linked.

### MILJÖ

Hållbar produktion och ett hållbart liv är två av vår tids viktigaste ämnen. Vi antar utmaningen och arbetar varje dag för att vår verksamhet ska ta ett ännu större miljö- och samhällsansvar. Så tar vi ansvar för miljön: För oss är ansvaret för både miljö och samhälle oskiljaktigt.

### SOSTENIBILITÀ

Stili di vita e di produzione sostenibili sono il tema principale e ricorrente della nostra epoca. Affrontiamo questa sfida e lavoriamo ogni giorno per rendere le nostre attività sempre più strettamente orientate all'interesse della tutela ambientale e della società. La sostenibilità noi la viviamo così: responsabilità di impresa, ambiente e società sono sempre legati indissolubilmente tra di loro.

### BÆREDYGTIGT

Bæredygtigt produktion og livstil er det vigtigste emne i vores tid. Vi tager denne udfordring op og arbejder hver dag på at bringe os endnu mere i harmoni med det miljø og samfund vi alle lever i. Så, vi lever bæredygtigt: For os er helhedsorienteret virksomhedsansvar forbundet med miljøet og samfundet.

## SUSTAINABLY UNPACKED - REFILL 2.0

Shopping with a clear conscience. Transparent storage containers that can be refilled again and again. The material is durable and hygienic. This is how you avoid plastic waste as far as possible: have the food filled directly into the storage containers at the no-packaging grocery store. It is precisely this philosophy that is scoring points with more and more customers with a green conscience. Thanks to the special holder, the storage containers always fit perfectly: on the niche railing, in the spice cabinet and in the larder unit. They can be easily removed and put back again. Because the containers are transparent you can see at any time when supplies are running low and the next purchase is due.

### SOSTENIBILE Y SIN ENVASE: REFILL 2.0

La compra sin remordimientos de conciencia. Los recipientes transparentes pueden rellenarse tantas veces como se desee. El material es duradero e higiénico. Comprar con estos recipientes en tiendas a granel apenas genera residuos de plástico. Esta filosofía cada vez está más extendida entre los clientes con conciencia ecológica. Los recipientes siempre combinan gracias al soporte especial, ya sea en el riel de un hueco, en el armario de pared de las especias o en un armario alto despensero. No cuesta nada sacar los recipientes y volverlos a dejar en su sitio. Con los recipientes transparentes es muy fácil ver si su contenido está a punto de acabarse e ir preparando la próxima compra.

### SFUSO È SOSTENIBILE - REFILL 2.0

Acquistare con la coscienza tranquilla. Barattoli trasparenti per le provviste, da tornare a riempire di volta in volta. Il materiale è igienico e di lunga durata. Per evitare il più possibile la produzione di rifiuti di plastica: i barattoli possono essere riempiti di alimenti direttamente nel negozio che li vende sfusi. È una filosofia che convince sempre più consumatori sensibili all'ambiente. Grazie ai supporti speciali, i barattoli sono sempre a portata di mano: sulla barra portaoggetti nella nicchia, nel pensile portaspezie e nella dispensa. Si tolgono e si ripongono con facilità. Con i barattoli trasparenti si controlla in ogni momento quando la scorta sta per finire e bisogna programmare i prossimi acquisti.

### BÆREDYGTIGHED UDEN EMBALLAGE - REFILL 2.0

Køb ind med god samvittighed. Transparente opbevaringsdåser, som altid kan fyldes op igen. Materialet er holdbart og hygiejnisk. Så kan du i mange tilfælde undgå plastikaffald: I de emballagefrie butikker kan levnedsmidlerne fyldes direkte i opbevaringsdåserne. For stadig flere mennesker, der tænker miljøbevidst, er denne filosofi vigtig. Takket være den specielle holder passer opbevaringsdåserne altid perfekt: På nichens kantliste, i krydderiskabet og i opbevaringshøjskabet. Der er let at tage dem ud og at sætte dem ind igen. Med de transparente dåser kan du altid se, når indholdet er ved at være brugt op, så du snart skal på indkøb igen.



EXCELLENT  
HEALTHY LIVING  
KITCHENS

COCINAS EXCELENTES DE  
VIDA SANA

AMBIENTE ECCEZIONALMENTE  
SALUBRE IN CUCINA

PRISBELØNNEDE KØKKENER  
MED SUNDT BOLIGMILJØ



WATER-BASED LACQUER FOR  
THE FRONTS FROM  
IN-HOUSE PRODUCTION

A BASE DE AGUA PARA  
LOS FRENTES DE FABRICACIÓN  
PROPIA

VERNICI A BASE DI ACQUA PER  
ANTE DI PRODUZIONE PROPRIA

VANDBASERET LAK AF EGEN  
PRODUKTION TIL FRONTERNE



CERTIFIED  
CARBON NEUTRAL PRO-  
DUCTION

PRODUCCIÓN CLIMÁTICA-  
MENTE NEUTRA CERTIFI-  
CADA

PRODUZIONE A IMPATTO  
ZERO SUL CLIMA  
CERTIFICATA

CERTIFICERET  
KLIMANEUTRAL  
PRODUKTION

# FRONT OVERVIEW

ÖVERSIKT AV FRONTER | ELENCO MODELLI | FRONTER – OVERSIGT



## PerfectSense®

The high-quality PerfectSense® surfaces convince with visual perfection as well as high resilience and durability. The surfaces finished with a layer of lacquer are giving the kitchen an exclusive and noble character.

*Las superficies PerfectSense® de alta calidad convencen por su perfección visual, así como por su gran durabilidad y resistencia. Las superficies lacadas proporcionan a la cocina un carácter exclusivo y noble.*

*La qualità delle superfici PerfectSense® si fa apprezzare sia per l'estetica perfetta, sia per le sue doti di elevata robustezza e resistenza. La speciale laccatura delle superfici conferisce alla cucina uno stile raffinato ed esclusivo.*

*PerfectSense®-overfladerne af høj kvalitet overbeviser med visuel perfektion, høj modstandskraft og lang holdbarhed. De lakerede overflader giver køkkenet et eksklusivt og raffineret udtryk.*

## UNO + ART PG 0 Coated in melamine resin/Fine structured | Revestimiento de melamina/Textura fina | Rivestimento in resina melaminica/struttura fine | Belægning med melaminharpiks/Fin struktur



Crystal white Blanco cristalino Bianco cristallo Krystal Hvid	Polar white Blanco polar Bianco polare Polar Hvid	White Blanco Bianco Hvid	Taupe Satén Satin	Crema-magnolia Crema-magnolia Crema-magnolia Crème – magnolie	Cashmere Cachemir Kashmire Kasmir
--	--	-----------------------------------	-------------------------	--	--



Pearl grey Gris perla Grigio perla Perlegrå	Graphite Grafito Grafite Graphite	Black Negro Nero Sort
--	--	--------------------------------

## TOP SOFT + ART PG 0 Direct lacquer satin | Laca directa mate | Laccatura diretta opaca | Direkte Matlak



Crystal white Blanco cristalino Bianco cristallo Krystal Hvid	Polar white Blanco polar Bianco polare Polar Hvid	White Blanco Bianco Hvid	Taupe Satén Satin Satin	Crema-magnolia Crema-magnolia Crema-magnolia Crème – magnolie	Cashmere Cachemir Cachemire Kasmir
--	--	-----------------------------------	----------------------------------	--	---



Pearl grey Gris perla Grigio perla Perlegrå	Graphite Grafito Grafite Graphite	Black Negro Nero Sort
--	--	--------------------------------

## TOP BRILLANT + ART PG 0 Shiny direct lacquer | Laca directa brillante | Laccatura diretta lucida | Direkte lakglans



Crystal white Blanco cristalino Bianco cristallo Krystal Hvid	Polar white Blanco polar Bianco polare Polar Hvid	White Blanco Bianco Hvid	Taupe Satén Satin Satin	Crema-magnolia Crema-magnolia Crema-magnolia Crème – magnolie	Cashmere Cachemir Cachemire Kasmir
--	--	-----------------------------------	----------------------------------	--	---



Pearl grey Gris perla Grigio perla Perlegrå	Graphite Grafito Grafite Graphite
--	--

## SCALA + ART PG 1 Coated in melamine resin/Fine structured | Revestimiento de melamina/Textura fina | Rivestimento in resina melaminica/struttura fine | Belægning med melaminharpiks/Fin struktur



Greige Greige Grigio-beige Grå	Olive green Verde olivo Verde oliva Olivengrøn	Amaranth Amaranto Amaranto Amarant
---	---	---

**COMET + ART PG 1** *Coated in melamine resin/Putty structure | Revestimiento de melamina/Textura enfoscado | Rivestimento in resina melaminica/Struttura spatolata | Belægning med melaminharpiks/Spatelstruktur*



Opal grey effect Gris opalino repro. Effetto grigio opale Opalgrå effekt	Pearl grey effect Gris perla repro. Effetto grigio perla Perlegrå effekt	Graphite effect Grafito repro. Effetto grafite Grafit effekt	Black effect Negro repro. Effetto nero Sort effekt
---	---	---	---

**METEOR + ART PG 1** *Coated in melamine resin/Ceramic structure | Revestimiento de melamina/Estructura cerámica | Rivestimento in resina melaminica/Struttura ceramicata | Belægning med melaminharpiks/Keramiskstruktur*

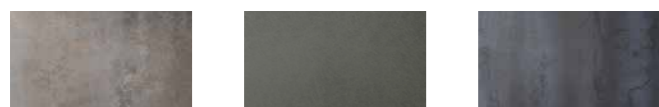

Oxide effect Óxido repro. Effetto ossido Oxid effekt	Brushed steel effect Acero cepillado repro. Effetto acciaio spazzolato Børstet stål effekt	Black steel effect Acero negro repro. Effetto acciaio nero Sort Stål effekt
---	---	--

**BALI + ART PG 1** *Coated in melamine resin/Wood structure | Revestimiento de melamina/Estructura de madera | Rivestimento in resina melaminica/Struttura legno | Belægning med melaminharpiks/Træstruktur*



Light summer oak effect Roble de verano luminoso repro. Effetto farnia chiara Lys sommereg effekt	Summer oak effect Roble de verano repro. Effetto farnia Sommer Eg effekt	Walnut effect Nogal repro. Effetto noce Valnød effekt
--	---	--

**TORONTO + ART PG 1** *Coated in melamine resin/Synchronous pore | Revestimiento de melamina/Poro sincronizado | Rivestimento in resina melaminica/Superficie sincroporo | Belægning med melaminharpiks/Synkron pore*



Natural vintage oak effect Roble envejecido natural repro. Effetto rovere antico natura Natural Vintage Eg effekt	Cognac vintage oak effect Roble envejecido coñac repro. Effetto rovere antico cognac Cognac Vintage Eg effekt	Black oak effect Roble negro repro. Effetto rovere nero Sort Eg effekt
--	--	---

**VANCOUVER + ART PG 1** *Coated in melamine resin/Synchronous pore | Revestimiento de melamina/Poro sincronizado | Rivestimento in resina melaminica/Superficie sincroporo | Belægning med melaminharpiks/Synkron pore*



Natural vintage oak effect Roble envejecido natural repro. Effetto rovere antico natura Natural Vintage Eg effekt	Cognac vintage oak effect Roble envejecido coñac repro. Effetto rovere antico cognac Cognac Vintage Eg effekt
--	--

**PERFECT SOFT + ART PG 2** *UV satin lacquer | UV laca mate satinada | Laccato opaco UV | UV Matlak*

PerfectSense®



Crystal white Blanco cristalino Bianco cristallo Krystal Hvid	Polar white Blanco polar Bianco polare Polar Hvid	White Blanco Bianco Hvid	Taupe Satén Satin Satin	Crema-magnolia Crema-magnolia Crema-magnolia Crème-magnolia	Cashmere Cachemir Cachemire Kasmir
--	--	-----------------------------------	----------------------------------	--	---



Pearl grey Gris perla Grigio perla Perlegrå	Graphite Grafito Grafite Graphite	Black Negro Nero Sort
--	--	--------------------------------

**PERFECT BRILLANT + ART PG 2** *UV high gloss lacquer | UV laca mate satinada | Laccato lucido UV | UV Højglans lakeret*

PerfectSense®



Crystal white Blanco cristalino Bianco cristallo Krystal Hvid	Polar white Blanco polar Bianco polare Polar Hvid	White Blanco Bianco Hvid	Taupe Satén Satin Satin	Crema-magnolia Crema-magnolia Crema-magnolia Crème-magnolia	Cashmere Cachemir Cachemire Kasmir
--	--	-----------------------------------	----------------------------------	--	---



Pearl grey Gris perla Grigio perla Perlegrå	Graphite Grafito Grafite Graphite
--	--

**MONTREAL + ART PG 2** *UV satin lacquer/Wood structure | Laca mate satinada ultravioleta/ Estructura de madera | Laccato opaco UV/Struttura legno | UV Matlak/Træstruktur*

PerfectSense®



Light fine oak effect Roble fino luminoso repro. Effetto rovere fine chiaro Lys eg effekt	Natural fine oak effect Roble fino natural repro. Effetto rovere fine naturale Eg natur effekt
--	---

**CALGARY + ART PG 2** *UV satin lacquer/Wood structure | Laca mate satinada ultravioleta/ Estructura de madera | Laccato opaco UV/Struttura legno | UV Matlak/Træstruktur*

PerfectSense®



Greige velvet oak effect Roble seda greige repro. Effetto rovere velluto grigio-beige Grå bøg effekt	Black velvet oak effect Roble seda negro repro. Effetto rovere velluto nero Sort bøg effekt
---	--

**MERKUR + ART PG 2**

UV satin lacquer | Laca mate UV | Laccato opaco UV | UV Mattlak

PerfectSense®



Carrara white effect Carrara blanco repro. Effetto carrara bianco Carrara Hvid effekt	Grey marble effect Mármol gris repro. Effetto marmo grigio Marmor Grå effekt	Marble dark effect Mármol oscuro repro. Effetto marmo scuro Mørk Marmor effekt
--	---	---

**LASER SOFT + ART PG 3**

Lacquer laminate ultra matt | Laca laminada ultramate | Foglio polimerico laccato opaco | Maling laminat mat



Crystal white Blanco cristalino Bianco cristallo Krystal Hvid	Polar white Blanco polar Bianco polare Polar Hvid	White Blanco Bianco Hvid	Taupe Satén Satin Satin	Crema-magnolia Crema-magnolia Crema-magnolia Crème-magnolia	Cashmere Cachemir Cachemire Kasmir
--	--	-----------------------------------	----------------------------------	--	---



Pearl grey Gris perla Grigio perla Perlegrå	Graphite Grafito Grafite Graphite	Black Negro Nero Sort
--	--	--------------------------------

**LASER BRILLANT + ART PG 3**

Lacquer laminate high gloss | Laca laminada alto brillo | Foglio polimerico laccato lucido | Maling laminat højlans



Crystal white Blanco cristalino Bianco cristallo Krystal Hvid	Polar white Blanco polar Bianco polare Polar Hvid	White Blanco Bianco Hvid	Taupe Satén Satin Satin	Crema-magnolia Crema-magnolia Crema-magnolia Crème-magnolia	Cashmere Cachemir Cachemire Kasmir
--	--	-----------------------------------	----------------------------------	--	---



Pearl grey Gris perla Grigio perla Perlegrå	Graphite Grafito Grafite Graphite
--	--

**ROMA PG 4**

Recycled ultra matt lacquer laminate | Laca laminada ultramate - reciclado | Foglio laccato opaco riciclato | Ultramat laklaminat - bæredygtigt



Crystal white Blanco cristalino Bianco cristallo Krystal Hvid	White Blanco Bianco Hvid	Taupe Satén Satin Satin	Crema-magnolia Crema-magnolia Crema-magnolia Crème-magnolia	Cashmere Cachemir Cachemire Kasmir	Pearl grey Gris perla Grigio perla Perlegrå
--	-----------------------------------	----------------------------------	--	---	--



Graphite Grafito Grafite Graphite	Black Negro Nero Sort
--	--------------------------------

**RAVENNA PG 4**

Recycled ultra matt lacquer laminate | Laca laminada ultramate - reciclado | Foglio laccato opaco riciclato | Ultramat laklaminat - bæredygtigt



Crystal white Blanco cristalino Bianco cristallo Krystal Hvid	White Blanco Bianco Hvid	Taupe Satén Satin Satin	Crema-magnolia Crema-magnolia Crema-magnolia Crème-magnolia	Cashmere Cachemir Cachemire Kasmir	Pearl grey Gris perla Grigio perla Perlegrå
--	-----------------------------------	----------------------------------	--	---	--



Graphite Grafito Grafite Graphite	Black Negro Nero Sort
--	--------------------------------

**PORTO + ART PG 5** *Satin lacquer | Laca mate | Laccato opaco | Matlak*



Crystal white Blanco cristalino Bianco cristallo Krystal Hvid	Polar white Blanco polar Bianco polare Polar Hvid	White Blanco Bianco Hvid	Taupe Satén Satin Satin	Crema-magnolia Crema-magnolia Crema-magnolia Crème-magnolia	Cashmere Cachemir Cachemire Kasmir
--	--	-----------------------------------	----------------------------------	--	---



Pearl grey Gris perla Grigio perla Perlegrå	Graphite Grafito Grafito Graphite	Black Negro Nero Sort
--	--	--------------------------------

**PORTO SELECTION + ART PG 5** *Satin lacquer | Laca mate | Laccato opaco | Matlak*



Eucalyptus Eucalipto Eucalipto Eukalyptus	Natural umber Umbra natural Terra d'ombra naturale Natur-umbra	Ocean Océano Oceano Ocean	Burgundy Borgoña Borgogna Vinrød	Azur Azur Azur Azur	Blackberry Blackberry Blackberry Blackberry
--	---	------------------------------------	---	------------------------------	--

**FARO + ART PG 5** *High gloss lacquer | Laca alto brillo | Laccato lucido brillante | Højglanslakeret*



Crystal white Blanco cristalino Bianco cristallo Krystal Hvid	Polar white Blanco polar Bianco polare Polar Hvid	White Blanco Bianco Hvid	Taupe Satén Satin Satin	Crema-magnolia Crema-magnolia Crema-magnolia Crème-magnolia	Cashmere Cachemir Cachemire Kasmir
--	--	-----------------------------------	----------------------------------	--	---



Pearl grey Gris perla Grigio perla Perlegrå	Graphite Grafito Grafito Graphite
--	--

**GRANADA PG 6** *High gloss lacquer | Lacado alto brillo | Laccato lucido brillante | Højglanslakeret*



White  
Blanco  
Bianco  
Hvid

**SMART + ART PG 6** *Polymerglass | Vidrio polimero | Vetro polimerico | Polymerglass*



Metallic sand grey effect Gris arena metálico repro. Effetto grigio sabbia metallizzato Sandgrå metallic effekt	Metallic stone grey effect Gris piedra metálico repro. Effetto grigio pietra metallizzato Stengrå metallic effekt	Metallic carbon effect Carbono metálico repro. Effetto carbonio metallizzato Carbon metallic effekt
--	--	--

**TOSKANA PG 7** *Satin lacquer | Laca mate satinada | Laccato opaco | Matlak*



Crystal white Blanco cristalino Bianco cristallo Krystal Hvid	White Blanco Bianco Hvid	Taupe Satén Satin Satin	Crema-magnolia Crema-magnolia Crema-magnolia Crème-magnolia	Cashmere Cachemir Cachemire Kasmir	Pearl grey Gris perla Grigio perla Perlegrå
--	-----------------------------------	----------------------------------	--	---	--



Graphite Grafito Grafito Graphite	Black Negro Nero Sort
--	--------------------------------

**TOSKANA SELECTION PG 7** *Satin lacquer | Laca mate satinada | Laccato opaco | Matlak*



Eucalyptus Eucalipto Eucalipto Eukalyptus	Natural umber Umbra natural Terra d'ombra naturale Natur-umbra	Ocean Océano Oceano Ocean	Burgundy Borgoña Borgogna Vinrød	Azur Azur Azur Azur	Blackberry Blackberry Blackberry Blackberry
--	---	------------------------------------	---	------------------------------	--

**MURANO SOFT + ART PG 7** *Glass 3 mm satined | Cristal 3mm satinado | Vetro 3mm satinato/satinada | Glas 3 mm - satineret*



Crystal white	Graphite	Black
Blanco cristalino	Grafito	Negro
Bianco cristallo	Grafite	Nero
Krystal Hvid	Graphite	Sort

**MURANO BRILLANT + ART PG 7** *Glass 3 mm shiny | Cristal 3mm brillante | Vetro 3mm lucido / lucida | Glas 3 mm - blankt*



Crystal white	Graphite
Blanco cristalino	Grafito
Bianco cristallo	Grafite
Krystal Hvid	Graphite

**BRISTOL PG 8** *Real wood lacquer | Madera auténtica lacada | Vero legno laccato | Lakeret ægte træ*



Crystal white	White	Taupe	Crema-magnolia	Cashmere	Pearl grey
Blanco cristalino	Blanco	Satén	Crema-magnolia	Cachemir	Gris perla
Bianco cristallo	Bianco	Satin	Crema-magnolia	Cachemire	Grigio perla
Krystal Hvid	Hvid	Satin	Crème-magnolia	Kasmir	Perlegrå



Graphite	Black	Pastel green	Agate blue	Velvet blue	Crimson red
Grafito	Negro	Verde pastel	Ágata azul	Azul seda	Rojo carmín
Grafite	Nero	Verde pastello	Agata blu	Blu velluto	Rosso carminio
Graphite	Sort	Pastelgrøn	Agatblå	Fløjlsblå	Purpurrød

**BRISTOL SELECTION PG 8** *Real wood lacquer | Madera auténtica lacada | Vero legno laccato | Lakeret ægte træ*



Eucalyptus	Natural umber	Ocean	Burgundy	Azur	Blackberry
Eucalipto	Umbr natural	Océano	Borgoña	Azur	Blackberry
Eucalipto	Terra d'ombra naturale	Oceano	Borgogna	Azur	Blackberry
Eukalyptus	Natur-umbr	Ocean	Vinrød	Azur	Blackberry

**HAMPTON + ART PG 8** *Real wood lacquer | Madera auténtica lacada | Vero legno laccato | Lakeret ægte træ*



Crystal white	White	Taupe	Crema-magnolia	Cashmere	Pearl grey
Blanco cristalino	Blanco	Satén	Crema-magnolia	Cachemir	Gris perla
Bianco cristallo	Bianco	Satin	Crema-magnolia	Cachemire	Grigio perla
Krystal Hvid	Hvid	Satin	Crème-magnolia	Kasmir	Perlegrå



Graphite	Black	Pastel green	Agate blue	Velvet blue	Crimson red
Grafito	Negro	Verde pastel	Ágata azul	Azul seda	Rojo carmín
Grafite	Nero	Verde pastello	Agata blu	Blu velluto	Rosso carminio
Graphite	Sort	Pastelgrøn	Agatblå	Fløjlsblå	Purpurrød

























**HAMPTON SELECTION + ART PG 8** *Real wood lacquer | Madera auténtica lacada | Vero legno laccato | Lakeret ægte træ*





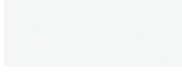





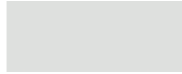













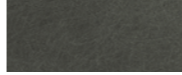



Eucalyptus	Natural umber	Ocean	Burgundy	Azur	Blackberry
Eucalipto	Umbr natural	Océano	Borgoña	Azur	Blackberry
Eucalipto	Terra d'ombra naturale	Oceano	Borgogna	Azur	Blackberry
Eukalyptus	Natur-umbr	Ocean	Vinrød	Azur	Blackberry

# WORKTOPS

ENCIMERAS | PIANI DI LAVORO | BORDPLADER

18	08	136	137	142
				
Arizona pine effect Pino arizona repro. Effetto pino arizona Arizona fyrtræ effekt	Silk grey oak effect Roble gris seda repro. Effetto rovere grigio seta Silkegrå effekt	Light fine oak effect Roble fino luminoso repro. Effetto rovere fine chiaro Lys Eg effekt	Natural fine oak effect Roble fino natural repro. Effetto rovere fine naturale Eg Natur effekt	Black fine oak effect Roble fino negro repro. Effetto rovere fine nero Eg sort effekt
146	149	126	73	127
				
Torino oak effect Roble torino repro. Effetto rovere torino Eg-torino repro	Venezia oak effect Roble venezia repro. Effetto rovere venezia Eg-venezia repro	Light summer oak effect Roble de verano luminoso repro. Effetto farnia chiara Lys Sommer Eg effekt	Summer oak effect Roble de verano repro. Effetto farnia Sommer Eg effekt	Summer oak silver-grey effect Roble de verano gris plata repro. Effetto farnia grigio argento Sommer Eg sølvgrå effekt
129	123	12	105	114
				
Natural vintage oak effect Roble envejecido natural repro. Effetto rovere antico naturale Natural Vintage Eg effekt	Cognac vintage oak effect Roble envejecido coñac repro. Effetto rovere antico cognac Cognac Vintage Eg effekt	Ontario oak effect Roble ontario repro. Effetto rovere ontario Ontario Eg effekt	Vintage oak effect Roble vintage repro. Effetto rovere vintage Vintage Eg effekt	Walnut effect Nogal repro. Effetto noce Valnød effekt
120	135	66	56	140
				
Mountain oak effect Roble montaña repro. Effetto rovere di montagna Mountain Eg effekt	Alpine oak effect Roble alpino repro. Effetto Rovere alpino Alpine Eg effekt	Natural oak grain-cut timber effect Roble madera de testa natural repro. Effetto rovere duramen naturale Natur Eg Endetræ effekt	Grey oak grain-cut timber effect Roble madera de testa gris repro. Effetto rovere duramen grigio Grå Eg Endetræ effekt	Natural walnut effect Nogal-natur repro. Effetto noce naturale Valnød Natur effekt
141	107 PerfectSense®	109 PerfectSense®	108 PerfectSense®	117 PerfectSense®
				
Dark walnut effect Nogal-oscuero repro. Effetto noce scuro Mørk Valnød effekt	Crystal white Blanco cristalino Bianco cristallo Krystal Hvid	Polar white Blanco polar Bianco polare Polarhvid	White Blanco Bianco Hvid	Crema-magnolia Crema-magnolia Crema-magnolia Crema-magnolia

143 PerfectSense®	110 PerfectSense®	118 PerfectSense®	121 PerfectSense®	111 PerfectSense®
				
Light grey Gris luminoso Grigio chiaro Lysegrå	Taupe Satén Satin Satin	Cashmere Cachemir Cachemire Kasmir	Pearl grey Gris perla Grigio perla Perlegrå	Graphite Grafito Grafite Graft
122 PerfectSense®	33	116	41	106
				
Black Negro Nero Sort	Ventura effect Ventura repro. Effetto rovere ventura Ventura effekt	Luna dark effect Luna oscuro repro. Effetto rovere Luna scura Luna mørk effekt	Light terrazzo effect Terrazzo claro repro. Effetto Terrazzo chiaro Lys Terazzo	Niagara effect Niagara repro. Effetto Niagara Niagara effekt
115	42	130	15	131
				
Limestone effect Caliza repro Effetto calcare Kalksten repro	Imperia brown effect Imperia marrón repro. Effetto imperia marrone Imperiabrun effekt	Light moon stone effect Piedra de la luna luminosa repro. Effetto pietra di Luna chiara Lys Månesten effekt	Oxide effect Óxido repro. Effetto ossido Oxid effekt	Grey limestone effect Caliza-gris repro. Effetto Pietra calcarea grigia Grå Kalksten effekt
132	51	134	133	150
				
Brushed steel effect Acero cepillado repro. Effetto acciaio spazzolato Stål børstet effekt	Black steel effect Acero negro repro. Effetto acciaio nero Sort Stål effekt	Basalt brown effect Marrón basalto repro. Effetto marrone basalto Basalt brun effekt	Marble anthracite effect Mármol antracita repro. Effetto marmo antracite Antracit marmor effekt	Green marble effect Mármol verde repro. Effetto marmo verde Marmor-grøn repro
95	39	101	125	113 PerfectSense®
				
Putty concrete opal grey effect Hormigón enfoscado gris opalino repro. Effetto calcestruzzo spatolato grigio opale Beton opalgrå effekt	Putty concrete pearl grey effect Hormigón enfoscado gris perla repro. Effetto calcestruzzo spatolato grigio perla Beton perlegrå effekt	Putty concrete graphite effect Hormigón enfoscado grafito repro. Effetto calcestruzzo spatolato grafite Beton grafit effekt	Putty concrete black effect Hormigón enfoscado negro repro. Effetto calcestruzzo spatolato nero Beton sort effekt	Carrara white effect Carrara blanco repro. Effetto carrara bianco Carrara hvid effekt
112 PerfectSense®	119 PerfectSense®			
				
Grey marble effect Mármol gris repro. Effetto Marmo grigio Marmor Grå effekt	Marble dark effect Mármol oscuro repro. Effetto Marmo scuro Mørk Marmor effekt			

# HANDLES

TIRADORES | MANIGLIE | GREB

Besides single handles and knobs, there are handle systems available, that are matching the cabinet widths.

*Además de botones y tiradores, hay muchos sistemas de agarre, que se suministran conforme a las anchuras del armario.*

*Oltre a pomelli e maniglie, sono possibili tanti sistemi di maniglia, abbinabili in base alla larghezza del armadi.*

*Ud over knopper og greb findes der mange grebssystemer, der leveres passende til skabsbredderne.*

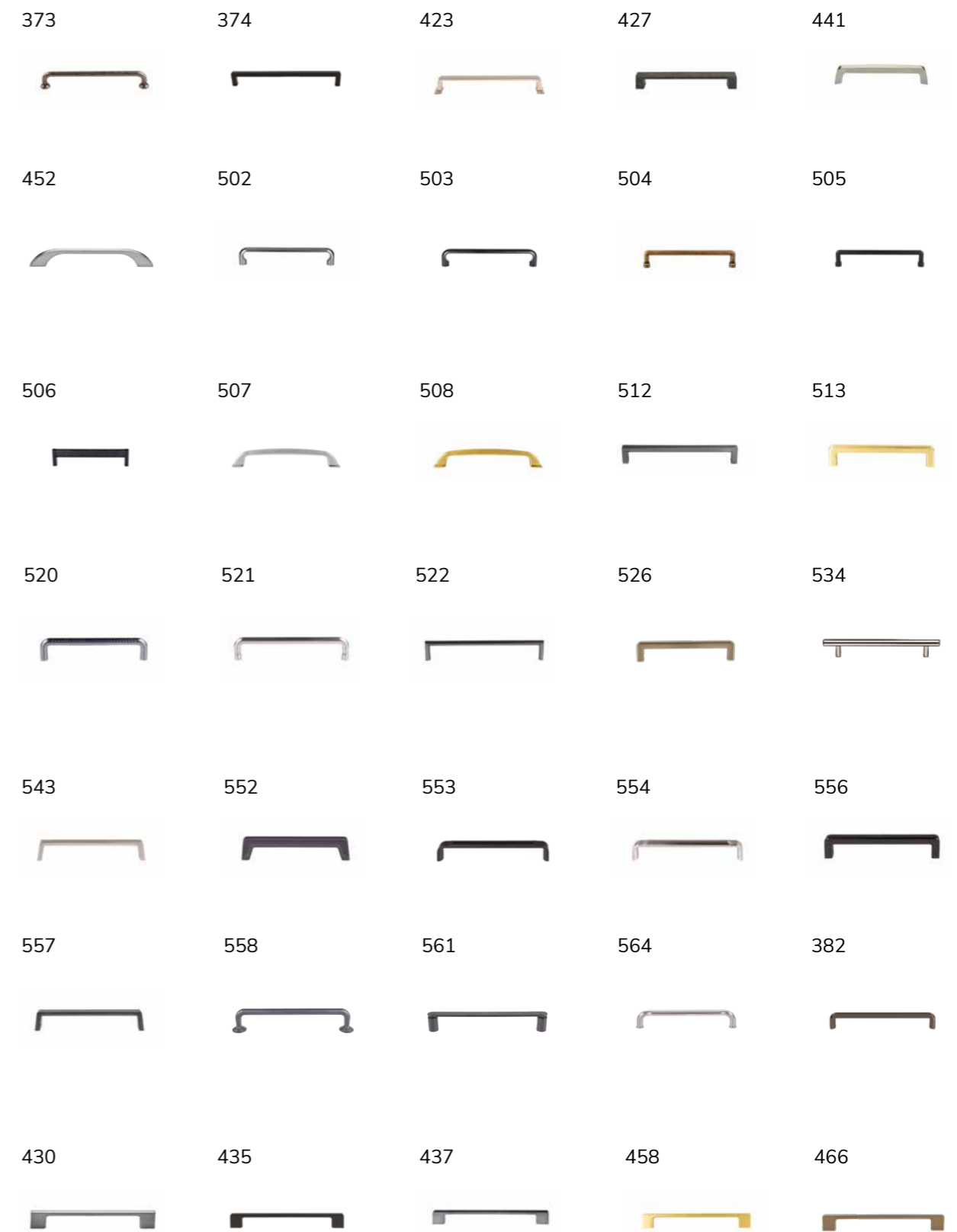



467



469



484



485



495



M 720



M 722



M 745



M 777



M 780



436



613



570



528



M 383



M 783



PTO1



M 384



M 375



M 376



B 615



B 550



B 624



B 535



M 530



M 527



M 542



M 421



M 562



# WE ARE CERTIFIED

SOMOS EXCELENTES | SIAMO CERTIFICATI | VI LIGGER I SPIDSEN

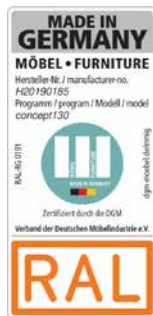

We reserve the right to alter sizes and specification of goods without notice and are not liable for printing errors. This catalogue supercedes previous catalogues.

*Reservado el derecho de modificaciones en el programa, material, modelo y medidas. Todos los ejemplos de instalación se entienden sin compromiso. Nos reservamos el derecho de notificar las erratas de imprenta. El presente catálogo invalida a todos los demás publicados hasta ahora.*

*Con riserva di modifiche riguardanti programma, materiali, esecuzione, dimensioni. Gli esempi di arredamento mostrati non sono impegnativi. Con riserva di correzione di eventuali errori di stampa. La pubblicazione del presente catalogo annulla tutti i cataloghi precedenti.*

*Forbehold for ændringer i programmet, materialet, udførelsen og målene. Alle indretningseksempler er uden forbindende. Forbehold for trykfejl. Med udgivelsen af dette katalog er alle foregående udgaver ugyldige.*

online version



[www.haecker-kuechen.de](http://www.haecker-kuechen.de)

Printed in Germany 08/2023  
Art.-Nr. MA-B-24

EN | ES | IT | DK